

**CARMICHAEL WATER DISTRICT &
SACRAMENTO SUBURBAN WATER DISTRICT**

**Business Case for a Potential
Combination**

STUDY REPORT / February 3, 2023



February 3, 2023

Mr. Daniel R. York, General Manager
c/o Ms. Heather Hernandez at hhernandez@sswd.org
Sacramento Suburban Water District
3701 Marconi Avenue, Suite 100
Sacramento, CA 95821

Ms. Cathy Lee, General Manager
Carmichael Water District
7837 Fair Oaks Boulevard
Carmichael, CA 95608

Subject: Business Case for a Potential Combination Study Report

Dear Mr. York & Ms. Lee:

Raftelis and Zanjero are pleased to provide this Business Case for a Potential Combination Study Report (Report) to Carmichael Water District (CWD) and Sacramento Suburban Water District (SSWD) as part of your ongoing efforts to ensure the continuation of high quality, reliable, and fiscally responsible service to each community.

The major objectives of the Study include the following:

- Identification of the advantages, disadvantages, opportunities, challenges, and risks of a possible utility combination, and in particular identification of any fatal flaws.
- Evaluation of the financial and operational business case for a potential utility combination.
- Development of recommended next steps on collaborative implementation of near-term shared service opportunities or longer-term utility combination.

The Report summarizes the key findings and recommendations related to the water utility combination business case evaluation.

It has been a pleasure working with you, and we thank you and the Districts' staff for the support provided during the course of this study.

Sincerely,



Zachary Green
Project Manager

Acknowledgments

Study authors include Zachary Green of Raftelis Financial Consultants, Inc. and Gwyn-Mohr Tully of Zanjero.

Along with our Project Sponsors at each district, which included Cathy Lee, General Manager at Carmichael Water District, and Dan York, General Manager at Sacramento Suburban Water District, we would like to acknowledge the contributors who supported this effort, for their commitment and contributions. These individuals devoted their time in service of the best interests of constituent customers in each district, as well as the local environment and economy. These include both Boards of Directors as well as a subgroup 2X2 Committee that engaged deeply on this work and provided consistent and meaningful input throughout the Study. We thank you for your dedication and efforts.

Carmichael Water District Staff and Board Members:

Ron Davis, Board Division 1 Director
Mark R. Emmerson, Board Division 2 Director (2X2 Committee Member)
Ron Greenwood, Board Division 4 Director
Cathy Lee, General Manager and Secretary to the Board (Project Sponsor)
Jeff Nelson, Board Division 3 Director (2X2 Committee Member)
Paul Selsky, Board Division 5 Director

Sacramento Suburban Water District Staff and Board Members:

Jay N. Boatright, Board President and Division 2 Director
David A. Jones, Board Division 1 Director (2X2 Committee Member)
Craig M. Locke, Board Division 5 Director (2X2 Committee Member)
Kevin M. Thomas, Board Vice President and Division 4 Director
Robert P. Wichert, Board Division 3 Director
Dan York, General Manager (Project Sponsor)

Contents

Contents

Executive Summary	1
1. Introduction	5
1.1. Background.....	5
1.2. Purpose of Study	7
1.3. Study Approach	7
2. Utility Overviews	9
2.1. CWD.....	9
2.1.1. System Description.....	9
2.1.2. Culture and Context.....	9
2.2. SSWD.....	9
2.2.1. System Description.....	10
2.2.2. Culture and Context.....	10
3. Organizational Assessment	11
3.1. Governance.....	11
3.1.1. History.....	11
3.1.2. Governing Bodies	12
3.1.3. Sacramento County LAFCo	14
3.1.4. Prior Agreements.....	17
3.2. Organizational Structure	17
3.3. Labor, Salaries, and Benefits	19
3.3.1. Labor Structure.....	19
3.3.2. Salaries.....	19
3.3.3. Benefits.....	20
3.4. Management & Administration	23
3.4.1. Utility Comparison.....	23
3.4.2. Opportunities.....	25
3.4.3. Challenges.....	26
3.5. Engineering.....	26
3.5.1. Utility Comparison.....	27

- 3.5.2. Opportunities.....27
- 3.5.3. Challenges.....27
- 3.6. Field Operations.....28**
- 3.6.1. Utility Comparison..... 28
- 3.6.2. Opportunities.....28
- 3.6.3. Challenges.....29
- 3.7. Water Production Operations29**
- 3.7.1. Utility Comparison..... 30
- 3.7.2. Opportunities.....30
- 3.7.3. Challenges.....30
- 4. Water Resources 32**
- 4.1. CWD and SSWD Water Asset Inventory.....32**
- 4.1.1. CWD’s Surface Water Rights..... 32
- 4.1.2. CWD Groundwater Supplies 38
- 4.1.3. SSWD’s Surface Water Assets 38
- 4.1.4. SSWD Groundwater Supplies..... 42
- 4.2. Future Changes to Water Rights and Supplies42**
- 4.2.1. Bay-Delta Water Quality Control Plan 42
- 4.2.2. Snowpack and Runoff Variation..... 43
- 4.2.3. Groundwater Banking and Extraction..... 43
- 4.3. The Opportunities43**
- 4.3.1. CWD’s Water Rights 43
- 4.3.2. CWD’s Other Supplies 45
- 4.3.3. SSWD’s Water Contracts..... 46
- 4.3.4. Conjunctive Management 46
- 4.4. Recommended Options for Water Asset Combination.....47**
- 4.4.1. City of Sacramento American River Water Rights..... 47
- 4.4.2. SJWD Pre-1914 Appropriative Right Deliveries 48
- 4.4.3. CWD’s License 1387 Conservation Transfer 48
- 4.4.4. GSWC Aerojet Supplies..... 48
- 5. Finances 49**
- 5.1. Bookkeeping.....49**
- 5.2. Revenues.....50**

5.3. Operating Expenditures.....	51
5.4. Normalized Expenditures	53
5.5. Capital Improvement Plans	56
5.6. Debt Considerations	60
5.6.1. Working Capital and Reserves.....	64
5.7. Rates.....	66
5.7.1. Sacramento Suburban Water District.....	66
5.7.2. Carmichael Water District	66
5.7.3. Rate Structure and Bill Comparison	66
5.8. Financial Business Case Summary.....	69
6. Communications	71
7. Timelines & Implementation.....	72
7.1. Current State	72
7.2. Transition Period.....	74
7.3. Future State.....	74
8. Conclusion.....	76

Tables

Table 1: Benefits Summary	21
Table 2: CWD's Surface Water Rights	33
Table 3: CWD Revenues FY2018 to FY2022.....	50
Table 4: SSWD Revenues FY2018 to FY2022.....	50
Table 5: Combined CWD and SSWD Revenues FY2018 to FY2022	51
Table 8: CWD Expenses FY2018 to FY2021	51
Table 9: SSWD Expenses FY2018 to FY2021	52
Table 10: Combined Expenses FY2018 to FY2021.....	52
Table 11: CWD Debt Obligations	61
Table 12: CWD Debt Service	61
Table 13: SSWD Debt Obligations	62
Table 14: SSWD Debt Service	62
Table 15: Combined Debt Service'	62
Table 16: Combined Debt Obligations'	63
Table 17: CWD FY2021 Unrestricted/Undesignated Reserves	65
Table 18: CWD FY2021 Designated Reserves	65
Table 19: CWD FY2021 Restricted Reserves	65
Table 20: SSWD FY2021 Reserves.....	65
Table 21: Summary of Current Rate Structures	67
Table 22: Possible Areas for Further Study.....	73

Figures

Figure 1: Sacramento County Water Suppliers	6
Figure 2: CWD District Map Showing Five Board Divisions.....	12
Figure 3: SSWD District Map Showing Five Board Divisions.....	13
Figure 4: Customer Accounts per Employee.....	18
Figure 5: Population Served per Employee.....	18
Figure 6: Diversion Rates for CWD's Water Rights	33
Figure 7: CWD Water Rights Place of Use Maps	35
Figure 8: Map Showing Area D in CWD's Service Area	37
Figure 9: Map Showing Area D in Relation to SSWD's and CWD's Service Areas.....	40

Figure 10: 2018 to 2021 Normalized Costs per Connection 53

Figure 11: 2018 to 2021 Normalized Cost per Million Gallons (MG) Produced 53

Figure 12: 2018 to 2021 Normalized Cost per MG w/o GSWC + Aerojet..... 54

Figure 13: 2018 to 2021 Normalized Cost per Mile of Pipe 55

Figure 14: 2018 to 2021 Normalized Cost per Population Served 55

Figure 15: 2018 to 2021 Normalized Cost per Acre..... 56

Figure 16: 2018 to 2031 CIP Spend 57

Figure 17: 2018 to 2031 CIP Per Connection..... 58

Figure 18: 2018 to 2031 CIP per Population Served 58

Figure 19: 2018 to 2031 CIP per Mile of Pipe..... 59

Figure 20: 2018 to 2031 CIP per Acre Area 59

Figure 21: 2018 to 2031 CIP per MG Produced 60

Figure 22: 2018 to 2031 CIP per MG Produced w/o GSWC + Aerojet..... 60

Figure 23: Total Outstanding Debt per Capita 63

Figure 24: 2017 to 2024 Bill Comparison for ¾” Meters 68

Figure 25: 2017 to 2024 Bill Comparison for 1” Meters 68

Appendices

Appendix A: CWD Organizational Chart..... 79

Appendix B: SSWD Organizational Chart 83

Appendix C: Example Interim Combined Organizational Chart 87

Appendix D: Example Long-Term Combined Organizational Chart..... 91

Appendix E: Position Compensation Comparison 95

Appendix F: Communications Plan 101

Acronyms

AB	Assembly Bill
AC-FT	Acre-Feet
ACWA JPIA	Association of California Water Agencies Joint Powers Insurance Authority
AD&D	Accidental Death and Dismemberment
AF	Acre-Feet
AFL / CIO	American Federation of Labor and Congress of Industrial Organizations
AFSCME	American Federation of State, County and Municipal Employees

AFY	Acre-Feet Per Year
AMI	Advanced Metering Infrastructure
AMR	Automated Meter Reading
ASR	Aquifer Storage and Recovery
AWD	Arcade Water District
AWWA	American Water Works Association
CalPERS	California Public Employees' Retirement System
CCF	Centum Cubic Feet
CFS	Cubic Feet Per Second
CI	Customer Information
CIP	Capital Improvement Plan
CIS	Customer Information System
CMMS	Computerized Maintenance Management System
COP	Certificate of Participation
CPI	Consumer Price Index
CTP	Cooperative Transmission Pipeline
CVP	Central Valley Project
CWD	Carmichael Water District
DDW	California Division of Drinking Water
DWR	California Department of Water Resources
FAQ	Frequently Asked Questions
FT	Full-Time
FTE	Full-Time Equivalent
FY	Fiscal Year
GASB	Governmental Accounting Standards Board
GC	Government Code
GET	Groundwater Extraction and Treatment
GFOA	Government Finance Officers Association
GIS	Geographic Information Systems
GM	General Manager
GPM	Gallons Per Minute
GSWC	Golden State Water Company
GW	Groundwater
HMO	Health Maintenance Organization
HOA	Homeowners Association
HR	Human Resources
IRS	Internal Revenue Service
IT	Information Technology
JPIA	Joint Powers Insurance Authority
LAFCo	Local Agency Formation Commission
LTD	Long-Term Disability
MG	Million Gallons
MGD	Million Gallons Per Day
MOU	Memorandum Of Understanding
MSR	Municipal Service Reviews

N/A	Not Applicable
NWD	Northridge Water District
O&M	Operations & Maintenance
PCWA	Placer County Water Agency
PEPRA	Public Employees' Pension Reform Act
PIO	Public Information Officer
POP	Population
PPO	Preferred Provider Organization
R-GPCD	Residential Gallons Per Capital Per Day
RWA	Regional Water Authority
SCADA	Supervisory Control And Data Acquisition
SCWA	Sacramento County Water Agency
SJWD	San Juan Water District
SMUD	Sacramento Municipal Utility District
SODU	Statement of Diversion and Use
SSWD	Sacramento Suburban Water District
STD	Short-Term Disability
SWRCB	State Water Resources Control Board
UARP	Upper American River Project
US or USA	United States or United States of America
W.D.	Water District

Executive Summary

Carmichael Water District (CWD) and Sacramento Suburban Water District (SSWD) partnered with Raftelis Financial Consultants, Inc. to conduct a Business Case Study for a Potential Combination (Study) of the two organizations. This Report represents a preliminary assessment to identify any fatal flaws of a potential combination. A more detailed assessment of the operational, funding, and financing considerations of such a combination will be addressed in future phases of analysis.

Given the limited water resources in the Sacramento region and across California, as well as evolving regulatory and customer demands, examining regional collaboration opportunities is imperative. It is important to recognize that this Study is being conducted in a time of high inflation and evolving regulations. These factors are creating significant upward pressure on rates. Utility costs are increasing rapidly. In addition, resources are more difficult to procure because of supply chain issues and the effects of “The Great Resignation.” Perhaps most significantly, utilities across the west are in an era of extreme drought that has touched the entire State of California and Sacramento Region in many ways. The realized effects include curtailments in the amount of water that can be extracted from existing surface water supply sources and an increasing emphasis on conservation that includes voluntary requests and mandated actions for customer usage reductions, penalties for repeat offenders, demand objectives, and water loss reductions.

CWD and SSWD initiated this Study to address their desire to gain efficiencies through collaboration. By way of collaboration, they hope to maximize value and minimize costs to customers, optimize water supplies and service levels, and improve the ability to advocate effectively during local and regional water policy discussions. Ultimately, the goal of the study is to objectively evaluate the potential benefits and risks of the combination of the two agencies, and if combination is found to be favorable, to develop an implementation path. In addition, a key goal of the Study was to conduct

This Study follows a series of prior efforts that looked at either regional collaboration or combination alternatives, each of which helped to focus and advance conversations between CWD and SSWD. SSWD and CWD, as well as many of the water agencies in the region, already have resource sharing and collaboration arrangements and there are several initiatives and agencies, such as the Regional Water Authority (RWA), that are actively working to form additional partnerships to address issues that impact the region and/or groups of utilities in and around Sacramento County. SSWD itself is a product of combination having been created through the merging of the Arden-Arcade Water District and the Northridge Water District. Over time, SSWD has come to recognize that effort as a successful one that allowed for better cost control and more reliable service. CWD has recognized the potential for scale and greater regional coordination to improve the sustainability of its services through an award-winning partnership with Golden State Water Company and Aerojet Rocketdyne.

This Study focuses on evaluating existing governance, operational, managerial, administrative, capital, and water supply functions as compared with potential future states of increasing collaboration and combination. Staffing and financial considerations are addressed for each function as well as at the organizational scale. To unlock opportunities for comparison of these two unique agencies, the Study focuses on unitized financials that put each organization and future state organization on an equal footing. Units of financial analysis include staff, customer, infrastructure, and water production measures that get at the efficiency of utility

operations. Ultimately, the Study evaluates these analytics to develop recommendations around possible next steps for the agencies' collective consideration.

There are both pros and cons to considering a combination of CWD and SSWD. Prominent pros include the following:

- Ability to achieve greater scale efficiencies through a larger organization: the two entities each have areas of strength, as well as under and over-utilized staff; combining the two entities could provide efficiencies if resources are used strategically
- Greater water resource sharing and utilization: maximizing the use of water resources is a complex process filled with regulatory and political hurdles, but with the portfolio of groundwater, purchased water, remediated, and surface water assets possessed by both Districts, there are significant opportunities to maximize resources
- Greater political advocacy: a larger organization that covers a broader service area will likely be able to increase its political advocacy in the region, helping it protect resources and ensure that it is appropriately represented so customers' needs are addressed
- Higher levels of customer service are possible by combining resources, allowing more specialization of staff, greater levels of scale efficiency, and perhaps new or expanded services
- More rate and financial stability are possible with a combined organization featuring a larger and more stable supply of water resources, a broader customer base, and an improved ability to deal with changes in operating conditions brought on by water resource challenges, staffing shortages, and inflation

While the pros to combination are significant, there are also notable cons including the following:

- A perceived loss of local control and the dilution of representation in a combined entity may be a concern; a combined entity would have Board members representing a larger number of constituents, assuming the Board is of the same size as the current Boards
- A larger organization often means more bureaucracy, and if not managed, redundancy and inefficiency; sound leadership will need to ensure scale efficiency is created while avoiding the pitfalls of a larger organization
- Adapting to changes can be challenging for staff, which requires attention and management effort to effectively navigate and thoughtfully consider as the new organization takes shape
- Challenges to water resources and/or limited ability to maximize resources: the regulatory and political environment may make it difficult to use water resources with maximum efficiency and could even invite some challenges to current arrangements

Two mechanisms for a potential combination are considered, as prescribed by state law, and administered by the Sacramento Local Area Formation Commission (LAFCo). Combining two or more public agencies (utilities) into one can be primarily achieved as either a consolidation or a reorganization (dissolution and subsequent annexation). The words "combination" or "combined" do not have a legal definition under LAFCo Law. This is in contrast to other words used colloquially like "merger" or "consolidation." The terms "consolidation" (as defined in Government Code §56030) and "reorganization" (as defined in Government Code §56073) have specific meanings. The end results are essentially the same: one agency assumes the rights, responsibilities, assets, and liabilities from others.

If combining the two Districts moves forward, one of the most significant activities will be aligning the staff and operations of the two entities. An approach that moves from current to interim and then to long term

arrangement is laid out. In the interim structure, all staff from SSWD and CWD would be retained, and water operations would largely continue as they do now. Functions would be slowly integrated over a period of a few years. This approach is least disruptive for both internal and external stakeholders. It allows the leadership of the combined entity to integrate operations carefully and deliberately. Conceptual (only) organizational charts are provided to show a theoretical view of how the organizations may be integrated in the interim and long term periods. Note these are not intended to be implemented as shown.

Integrating systems such as Computerized Maintenance Management System (CMMS), GIS, and Customer Information/ Billing (CIS), as well as processes like accounting, record keeping, and contracting would be tackled during the interim period. There would be costs and a considerable amount of staff time involved in the interim period. Essentially, these activities could be managed largely as they are now until full integration occurs. Current capital plans and activities could also be maintained in the interim period to ensure minimal disruption. Over the interim period, integration would be needed to achieve the scale efficiencies and other benefits afforded by combination. Raffelis estimates that a combined entity could at least achieve the same level of labor efficiency that SSWD currently achieves, which delivers services for 156% of the number of accounts on a per employee basis as compared with CWD per the figure below.

Customer Accounts per Employee

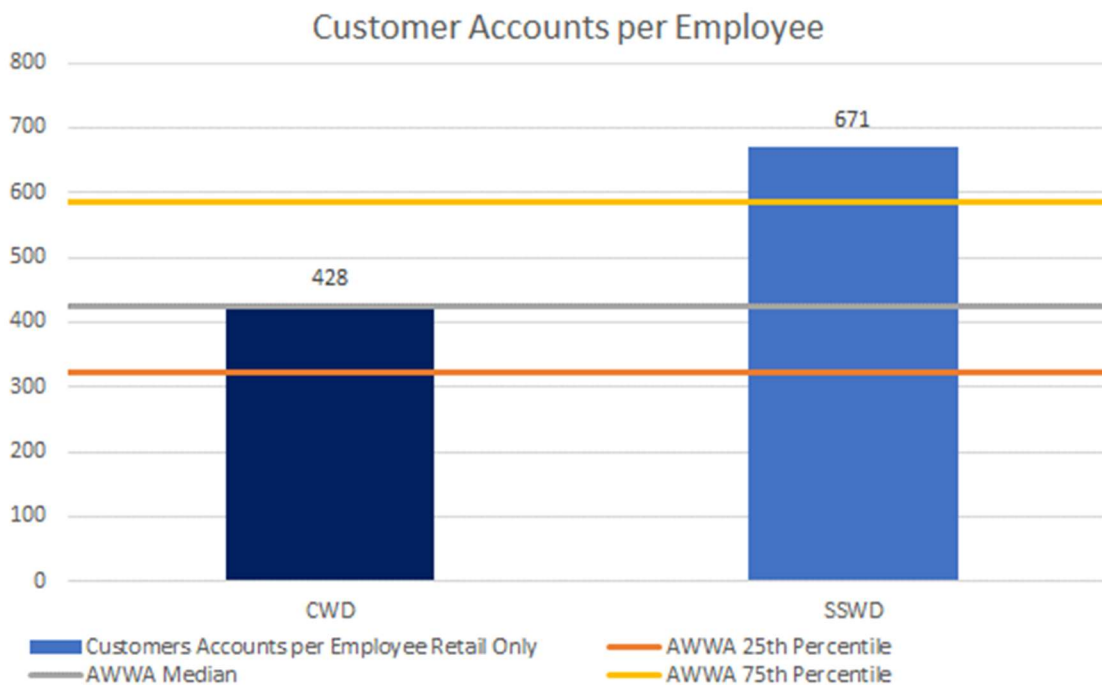

In the prior regional study of collaboration¹ opportunities in the Sacramento area conducted with CWD, SSWD, and a broader set of utilities, repeatable avoided cost ranges on the order of 8-20% relative to uncombined organizations were noted for utility consolidations. Such repeatable savings may be attributable to combined facilities, staff right sizing, labor specialization or a range of operational opportunities through joint contracting, purchasing power, or other initiatives. Such levels again appear achievable between CWD and SSWD if the aforementioned 20-30% lower costs at SSWD are spread across normalized retail services. A key unknown variable is the monetization of water supplies, which could further drive economic benefits in

¹ <https://www.sswd.org/about/sacramento-regional-water-utility-collaboration-study-reports>

this case. Overall, worker productivity gains attributable to increased specialization, systems optimization, and the ability of the combined larger ratepayer base to bring down costs per unit and drive additional efficiencies appear to present opportunities for savings.

In addition to broadly expected savings due to scale efficiency and worker specialization, within 10 years of a combination several specific areas are worth highlighting as potential drivers of savings. Note that in some cases these potential savings may require up front expenditures to achieve them. Areas of expected savings over 10 years include, but are not limited to:

- Elimination of redundant staff salary and benefits (achieved through attrition or elimination of vacant budgeted positions as deemed appropriate by management)
- Providing benefits cost parity in line with current SSWD lower cost levels
- Consolidating existing legal services expenditures
- Consolidating the Board
- Collective monetization of water supply assets (in particular this effort could involve legal and other costs in the first 0-5 years of pursuit before yielding repeatable net benefits, which could be significant)

In addition, there are several areas where combination related activities may result in net costs. These include, but are not limited to:

- Providing salary parity, as SSWD salaries are higher
- Software & technology investments and studies required to align IT infrastructure
- Staff and facility relocation costs
- Additional combination-related studies or legal costs

Finally, it is important to remember that, in addition to the financial upside of a potential combination estimated at 8 to 20% in total, it is the increased ability to manage supplies, implement best practices, and provide quality and reliable service to customers that must also be qualitatively considered in any agency combination business case exercise.

Overall, the business case evaluation did not yield any fundamental barriers to combining agencies. Financial expectations are higher to the upside than to the downside, particularly over the longer-term. While there are initial net costs to combining, these would likely be outweighed by operational benefits and service reliability improvements, particularly once the combined agency refines its operational model and matures.

The Study provides a high-level implementation timeline that features a likely series of events that would occur should SSWD and CWD desire to pursue combination. It begins with a thorough review of the considerations laid out in this Study and must be initiated by an affirmative vote from each of the Boards of SSWD and CWD. Note that how and when the Boards vote, and whether they pursue consolidation or reorganization as defined by the LAFCo Law, is important because it has implications with customer outreach and other procedures. Customer communication will be a key consideration and should be initiated early in the process.

1. Introduction

Carmichael Water District (CWD) and Sacramento Suburban Water District (SSWD) contracted with Raftelis Financial Consultant, Inc. to conduct a Business Case Study for a Potential Combination (Study) of the two organizations. Note that the term “combination” is used in place of similar words such as consolidation, merger, and reorganization, some of which have distinct meanings for regulatory agencies such as the Sacramento Local Agency Formation Commission. This Report details the findings of the Study in full and provides recommendations about possible next steps for consideration.

1.1. Background

There are at least 28 different water entities, both public and private, serving Sacramento County, as shown in Figure 1. Given the limited water resources in the region and across California, as well as evolving regulatory and customer demands, and increasing pressures on water rates, examining regional collaboration opportunities is imperative. Many of the water agencies in the region already have resource sharing and collaboration arrangements. In addition, there are several initiatives and agencies, such as the Regional Water Authority (RWA), that work to form partnerships to address issues that impact the region and/or groups of utilities in and around Sacramento County.

Figure 1: Sacramento County Water Suppliers

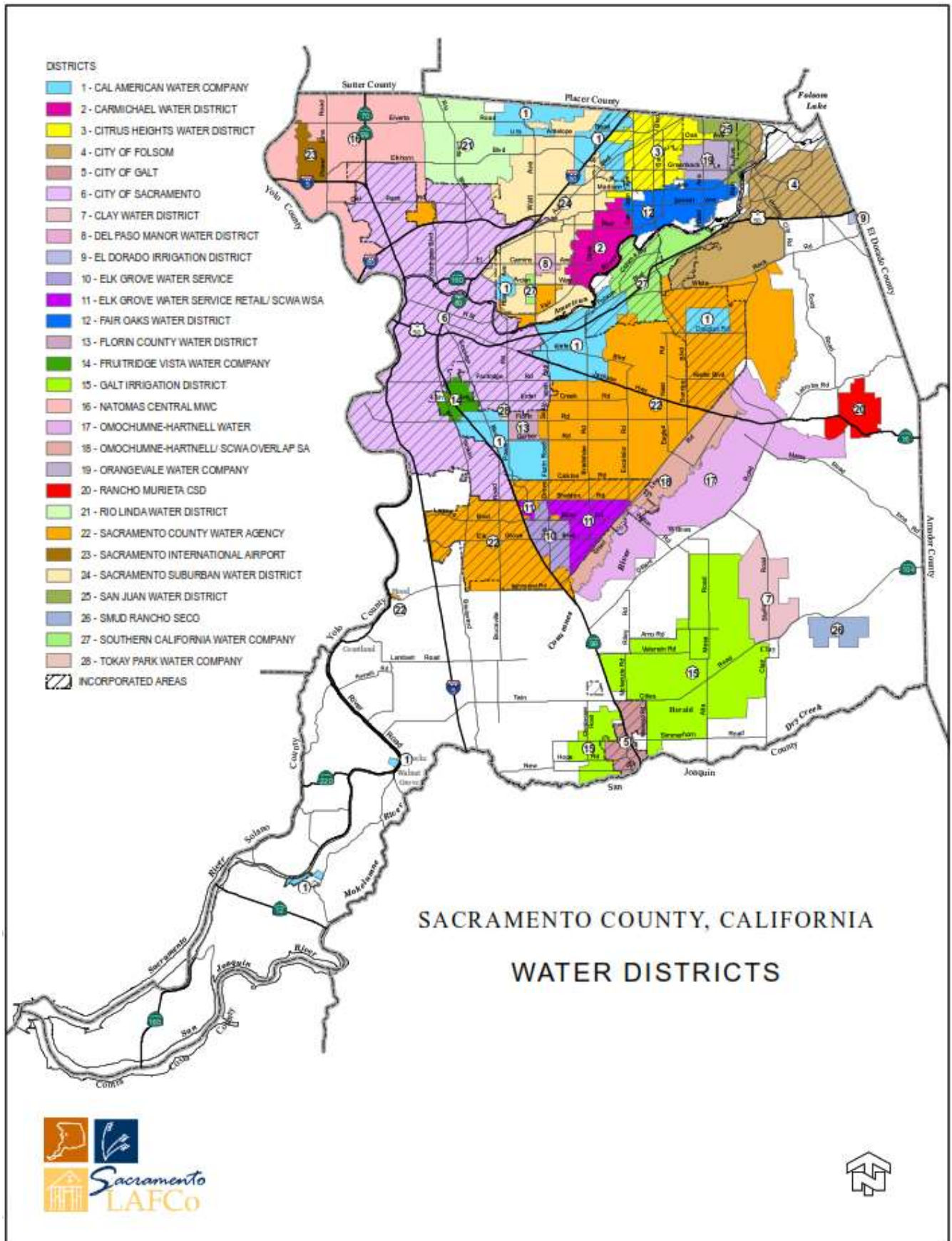

This Study follows a series of prior efforts that looked at either regional collaboration or combination alternatives, each of which helped to focus and advance conversations between CWD and SSWD. One of those studies was conducted by Raftelis and, while its focus was on shared services among a broader set of stakeholders that included CWD and SSWD, that effort highlighted that the opportunities to gain efficiencies and enhance service levels appeared to be greatest under a fully combined model.

SSWD itself is a product of combination, having been created through the merging of the Arcade Water District and the Northridge Water District. Over time SSWD has come to recognize that effort as a successful one that allowed for better cost control and more reliable service. CWD has recognized the potential for scale and greater regional coordination to improve the sustainability of its services through an award-winning partnership with Golden State Water Company and Aerojet Rocketdyne.

It is important to recognize that this Study is being conducted in time of high inflation and evolving regulations. These factors are creating significant upward pressure on water rates. Costs are increasing rapidly. In addition, resources are more difficult to procure because of supply chain issues and the effects of “The Great Resignation.” Perhaps most significantly, utilities across the west are in an era of extreme drought that has touched the entire State of California and Sacramento Region in many ways. The realized effects include curtailments in the amount of water that can be extracted from existing sources and an increasing emphasis on conservation that includes largely voluntary requests for customer usage reductions and penalties for repeat offenders. This has subsequently reduced usage per capita and resulted in the need for ever nimble rate setting practices. The potential effects, however, are more severe, and include but are not limited to limited (dwindling) water supply sources and customer restrictions on water usage along with increasingly strict enforcement and penalties, and additional environmental water supply needs. While the resiliency of the participating utilities that results from the seniority and variety of their water sources, as well as the quality of their management, has prevented CWD and SSWD from enduring the most extreme effects of the drought, it is apparent that the need to remain vigilant in the pursuit of resilient utility operations will continue to increase over time. Given the mix of water resources and differences in scale between the organizations, there appears to be an opportunity to develop a deeper and perhaps fundamental connection for the mutual benefit of both Districts.

1.2. Purpose of Study

CWD and SSWD initiated this Study to address their desire to gain efficiencies through collaboration. Through collaboration they hope to maximize value and minimize costs to customers, optimize water supplies and service levels, and improve the ability to advocate effectively during local and regional water policy discussions. Ultimately, the goal of the study is to objectively evaluate the potential benefits and risks of a potential combination of the two agencies, and if combination is found to be favorable, to develop an implementation path. Another objective was to identify any fatal flaws before next steps are taken. A more detailed assessment of the operational, funding, and financing considerations of such a combination will be addressed in future phases of analysis.

1.3. Study Approach

Raftelis’ approach to this Study focuses on evaluating existing governance, operational, managerial, administrative, capital, water supply functions as compared with potential future states of increasing collaboration and combination. Staffing and financial considerations are addressed for each function as well as at the organizational scale. To unlock opportunities for comparison of these two unique agencies, the

Study focuses on unitized financials that put each organization and future state organization on an equal footing. Units of financial analysis include staff, customer, infrastructure, and water production measures that get at the efficiency of utility operations. Ultimately, we evaluate these analytics to develop recommendations around possible next steps for the agencies' collective consideration.

As we engaged in the Study it became clear that specific areas of consideration required significant attention given the potential hurdles that they presented. These include:

- Board Structure
- Sacramento Local Area Formation Commission (LAFCo)
- Prior Agreements
- Labor
- Finance
- Water Resources

As neutral evaluators and advisors, the goal is to identify solutions for the agencies that help achieve their mission of providing high quality and reliable water service that balances sustainability and affordability for customers, and is in-line with applicable laws. To that end, we have supplemented our organizational analytics with content developed by legal experts from Zanjero with expertise in California water supply regulations and Raftelis staff experts in stakeholder outreach and communications. All of this work was done in collaboration with the two Districts and their representatives.

Raftelis worked to follow the data wherever it took us. We recognize that there are staff, Board, and community members at each agency that are likely to be initially either in favor of or against the idea of a potential combination, and as such we have taken great care to be objective in this analysis. We have attempted to highlight the opportunities and challenges of a potential combination, while acknowledging that such an endeavor is a complex exercise, and particularly so in a water stressed region governed by western and California water laws and in an era of political polarization.

2. Utility Overviews

This section provides introductory information such as system descriptions and the characteristics of each agency. It is critical to understand the current state of these two agencies as they investigate forming deeper connections with each other. Further, topline information introduced here is used in downstream analytics and discussion throughout the report.

2.1. CWD

CWD was established as an Irrigation District in 1916. The District serves a predominantly residential suburban community and does not serve any major industrial customers that account for a large percentage of water sales within its service area. There are 12,000 customer connections that represent a population served of about 40,000 people by the CWD.

2.1.1. System Description

CWD largely sources its water from the American River with supplemental groundwater wells in high demand seasons. With the dual water supplies, CWD practices conjunctive use and has banked groundwater via in-lieu recharge. American River water is treated at a micro filtration plant that CWD invested significantly since 2002. During times of drought, when withdrawals from the river become limited, CWD is fortunate to have access to supply from groundwater wells to help meet customer demands. In the summers of 2014, 2015, 2021, and 2022 the State of California ordered CWD to stop all withdrawals from the American River because of water scarcity.

CWD maintains nearly 160 miles of pipe and supplies an average of just under 9,000 acre-feet of water annually to its customers. CWD is 100% metered with a mix of mechanical and digital AMR (truck-read) flow meters.

2.1.2. Culture and Context

Customers are engaged on water issues and are reportedly happy with the quality and services that CWD provides. CWD reports that customers like the small town feel of the District, and that, while they take pride in their independence, they are certainly open to collaborative opportunities that could achieve efficiencies through the sharing of resources. As the Study progresses and in the context of ongoing economic uncertainty resulting from the Covid-19 pandemic, CWD notes that both union and non-union employees will want assurances that collaboration efforts will not threaten their jobs, benefits, or labor structure.

As a result of their dual surface and groundwater supply, award-winning public-private-partnership supply agreement, and their position relative to peers, CWD has the potential to be an important voice for the benefits of collaboration, while maintaining appropriate independence.

2.2. SSWD

SSWD is a larger utility that was formed as a County Water District in February 2002, through the consolidation of the former Arcade Water District and Northridge Water District, which were formed in 1954 and 1956, respectively. There over 47,000 customers accounts representing a population of nearly 200,000 people.

2.2.1. System Description

SSWD continues to make investments in several areas including infrastructure replacement and a conjunctive use program. SSWD is reliant on groundwater, but has contractual surface water rights to 26,064 acre-feet per year of surface water from the City of Sacramento water entitlement; and a contract to purchase up to 29,000 acre-feet of surface water per year from Placer County Water Authority (PCWA), with a 8,000 acre-feet take or pay caveat in the agreement. SSWD's conjunctive use program has resulted in approximately 240,000 acre-feet of banked groundwater. The District delivers water through a network of nearly 700 miles of pipe. Since 2005, SSWD has replaced approximately 100 miles of its distribution system at a cost of approximately \$110 million.

SSWD works to invest in technologies that enhance operational efficiency. The District is approximately 99.6% metered; and is on schedule to be 100% metered by the end of 2022. SSWD has installed Advanced Metering Infrastructure (AMI) meters that can be read remotely for all customers. SSWD's Computerized Maintenance Management System (CMMS) is CityWorks. In 2007, SSWD chose to fully implement the CMMS system by placing a computer in each District vehicle.

2.2.2. Culture and Context

While SSWD's staff of 73 meets the agency's baseline needs and has little excess capacity, there are select areas where SSWD may be able to share or enhance services in collaboration with other agencies. For example, SSWD expressed openness to exploring opportunities for new shared FTEs in the Regional Collaboration Study² to enhance scale efficiencies. In addition, as a large district with a robust mix of ground and surface water assets, SSWD seeks to continue to identify opportunities to diversify the resiliency and quality of its water supplies.

Prior to this Study, SSWD engaged in an effort with San Juan Water District (SJWD)³ looking at consolidation, which was largely motivated by opportunities to reduce operational redundancies and the potential for enhanced reliability that would be offered by having access to surface water during certain periods. SSWD then engaged with a multi-agency study⁴ (facilitated by Raftelis and including CWD and others) to look at collaboration (rather than combination). The study found many opportunities to achieve savings or service level improvements as a region through collaboration or combinations.

² <https://www.sswd.org/about/sacramento-regional-water-utility-collaboration-study-reports>

³ <https://www.sswd.org/modules/showdocument.aspx?documentid=6790>

3. Organizational Assessment

An assessment of each organization's high-level structures and utility functions highlights the similarities and differences of CWD and SSWD and helps clarify future state considerations. First, the assessment covers internal governance structures and external bodies that will inform a potential combination. Next, the assessment addresses labor considerations broadly before covering the range of utility functions individually to identify the similarities, differences, opportunities, and challenges that each present in this context. Following the organizational assessment is a comprehensive analysis of agency Water Resources (Section 4) and Finances (Section 5), though elements of those sections are included throughout this section as needed to inform the business case.

3.1. Governance

Organizational and governance structures provide the framework for decision-making and service delivery for CWD and SSWD. In addition to internal structures, the agencies must consider how LAFCo, and the State Water Resources Control Board, Division of Drinking Water will inform any potential next steps towards a combination.

We begin the comparative analyses with an overview of both the existing internal and then the potential external governance structures and how they will be impacted by and inform a combination.

3.1.1. History

CWD and SSWD are both special districts under California law, with the former having been created as an Irrigation District and the latter a County Water District from two other county water districts. However, these distinctions do not appear to be barriers to a combination as functionally their responsibilities, authorities, and regulations are largely the same, and there are numerous precedent examples of irrigation districts and county water districts merging. A county water district is considered a higher level of organizational constitution and as such a combination of CWD and SSWD would likely take that form rather than an irrigation district. CWD has existed as a single organization for its entire 100 plus year history, while SSWD was the result of a fairly recent merger of the Arcade Water District and the Northridge Water District in 2002. For CWD, its long history as a standalone organization must be considered when engaging with stakeholders as any consideration of a loss of autonomy or local control may be met with more scrutiny, relative to SSWD, which is itself a product of a recent combination.

The two prior studies of combination and collaboration opportunities that set the stage for this Study are important to consider as this next level of analysis is reviewed. The initial investigation of a combination of SSWD and San Juan Water District (SJWD) did identify advantages to expanding organizational scale and regional integration. Indeed, the subsequent study of collaboration opportunities was better received by the smaller participating agencies, which included SSWD, SJWD, and several of its wholesale customers as well as the City of Folsom and CWD. It can be said that the sheer number of opportunities for shared service, as well as the potential for even greater cost avoidance and service level enhancement through combination that emerged in the regional study added to momentum for this study. This Study will be constructive to further building regional momentum for collaboration, as it provides an opportunity to carefully consider the practical realities of an integration between two agencies that may serve as an example to the complex regional web of stakeholders. Regional collaboration, including combination, is more challenging to examine

deeply all at once than it is between just two agencies. Still those prior efforts are an important piece of the history that led to this Study and include relevant information that was leveraged for this Study in several sections of the Report.

3.1.2. Governing Bodies

CWD’s Board of Directors consists of five members which represent proportional shares of the District’s population. Each Director serves a four-year staggered term. Figure 2 includes a map detailing the five Divisions of CWD, each of which are represented on the Board by one Director.

Figure 2: CWD District Map Showing Five Board Divisions

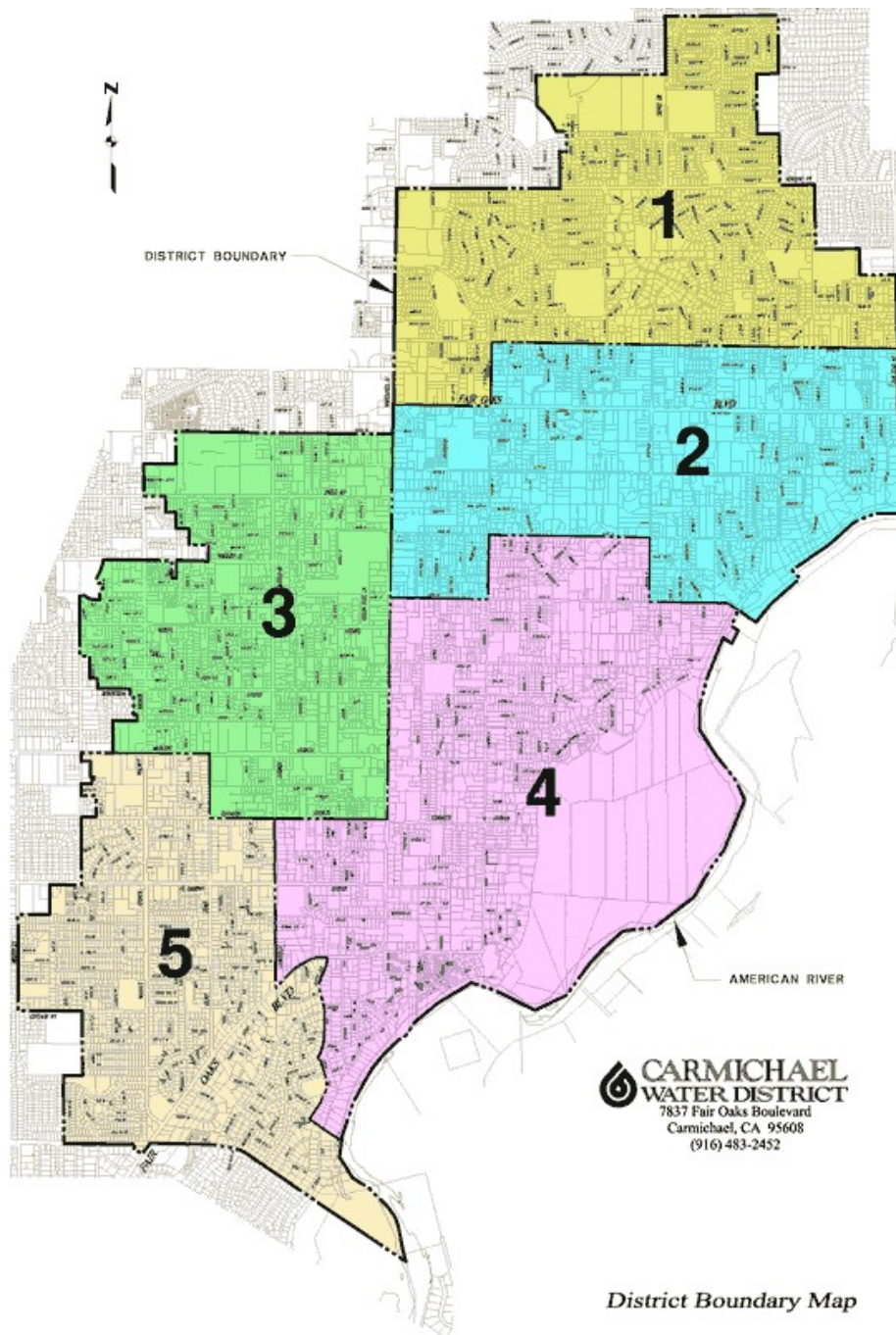

SSWD’s Board of Directors consists of five members which represent proportional shares of the District’s population. Figure 3 includes a map detailing the five Divisions of SSWD, each of which are represented on the Board by one Director. Board Members are elected to staggered four-year terms with elections occurring in all even numbered years.

Figure 3: SSWD District Map Showing Five Board Divisions

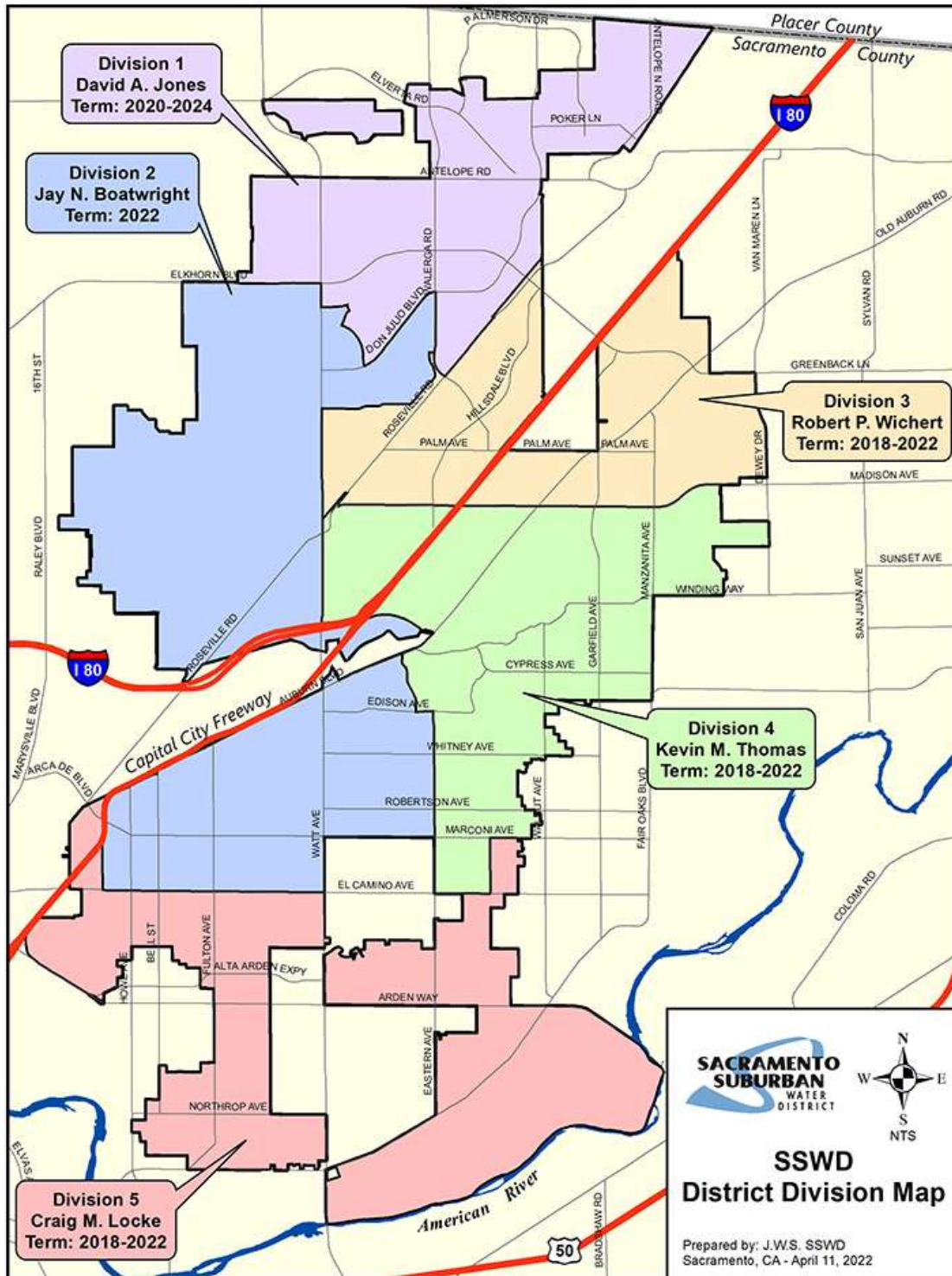

Any steps towards a combination will require the actions of the Boards, and subsequently, a fully combined organization would include a revised Board structure. Typically, an odd numbered Board size of perhaps nine initially, and ultimately five to seven members is considered ideal to ensure critical mass for executing duties, an odd number to discourage tie voting, and a manageable headcount to avoid excessive deliberations and cumbersome bureaucracy.⁴ Indeed, the progression from two separate five member boards to nine⁵, seven, and five is what proceeded when Arcade and Northridge combined to form SSWD. This presents a potential conflict for existing Board members should they feel that their seat is threatened. This tension can be mitigated by developing a transition plan for the agencies that recognizes and addresses this conflict directly. For example, an interim structure could be developed that maintains all or perhaps one less Board seat and phases more out as terms expire over time. The local LAFCo agency can help with this transition, as it has the power to approve a transition plan document submitted by the agencies under review, to formalize the roadmap from the current state to a combined framework. Typically, Boards will experience some natural turnover and so a transition phase may allow for natural Board attrition without forcing any departures to accomplish the desired end state. If board expenses are ultimately fully halved this could result in up to \$1.05 million in savings over 10 years.

3.1.3. Sacramento County LAFCo

LAFCos were created by the State of California in response to rapid growth experienced in the 20th century and the urban sprawl that resulted. Each LAFCo works with residents, their parent county, and any cities and special districts in their region on jurisdictional issues to discourage urban sprawl and encourage the orderly formation of appropriate local agencies. A regular part of a LAFCo's duties is to review special districts to ensure services are being provided in a cost-effective manner.⁶ LAFCos have the authority to approve and manage combination efforts, as well enable the transition from one organizational form to another. Applications for combination, and some forms of collaboration, need to be submitted to the local LAFCo for review, public engagement, and approval. LAFCos are able to work with agencies to provide guidance and temporary rules to facilitate combination. This can include arrangements for transitioning Board seats and finances between agencies, or consolidating them in the case of a combination of two or more entities. As part of a consolidation or collaboration process, CWD and SSWD will need to develop a plan for approval with the LAFCo of Sacramento County. The State Water Resources Control Board, Division of Drinking Water, provides support resources and have some high level involvement (process outline, permitting, water supply questions, etc.) in any process of combination, but their materials do appear to heavily defer to engagement through LAFCos.⁷

The Sacramento LAFCo provided information specifically about a possible combination between SSWD and CWD, which we have included excerpts from and summarized as follows:

In the LAFCo context, there are a number of terms related to consolidation that have specific definitions. The words “combination” or “combined” do not have a legal definition under LAFCo Law. This is in contrast to other words used colloquially like “merger” or “consolidation.” The terms “consolidation” (as defined in

⁴ <https://www.diligent.com/insights/board-composition/why-your-board-size-matters-how-a-smaller-board-can-be-more-effective/>

⁵ One member voluntarily resigned at the outset of the Arcade-Northridge combination.

⁶ Sacramento County Local Agency Formation Commission, History, <https://sacdafco.saccounty.gov/AboutUs/Pages/WhatsLafco.aspx>

⁷ https://calafco.org/sites/default/files/resources/2017_Staff_Workshop/Water%20Consolidations_SWRCB%20presentation.pdf, https://www.waterboards.ca.gov/drinking_water/certlic/drinkingwater/consolidation.html

Government Code §56030) and “reorganization” (as defined in Government Code §56073)” have specific meanings. Combining two or more public agencies (utilities) into one can be primarily achieved as either a consolidation or a reorganization (dissolution and subsequent annexation). The end results are essentially the same: one agency assumes the rights, responsibilities, assets, and liabilities from others. There are several quirks to this process.

In a consolidation, all agencies are dissolved and a new one is created in their place with a service area that encompasses the previous districts’ service areas. The new agency is the successor entity. This was the approach taken when SSWD was created following the dissolution of the Arcade and Northridge Water Districts. The process initiates when both agencies file for consolidation. In a reorganization, one or more districts are dissolved and one agency annexes all or a portion of their former service areas. An existing agency is the successor entity. The process initiates when one or more districts applies to dissolve, and the remaining district applies to annex the service area of the dissolved district(s).

Either district can initiate these processes by adopting a resolution of application and going through the “normal” LAFCo process. However, there is a sub-LAFCo process that is likely applicable: Government Code §56853(a) states that if the combining agencies adopt *substantially similar* resolutions of application, LAFCo must either approve or conditionally approve the proposal (in other words LAFCo cannot deny the application). In fact, this exact Code was applied to create SSWD from the Arcade and Northridge Water Districts. In addition, this section says that the reorganization could be ordered by LAFCo without an election unless the conditions under GC §57081(b) are met. After the approval hearing, a second hearing (called a conducting authority hearing or a protest hearing) must be held, but only to determine if the conditions specified in GC §57081(b) exist.

There are some nuances. General elections are not automatic under this process; however, landowners and registered voters can potentially force one. If the districts opt for the reorganization route, and if the Board of the dissolving district adopts the resolution for dissolution unanimously, then, under Government Code §57077.1(c), LAFCo is also empowered to waive the Conducting Authority Hearing for the dissolution only. If the LAFCo approves and takes the appropriate administrative steps in GC §56663 when providing the hearing notice, then the Conducting Authority Hearing can be waived for the annexation portion.

Ultimately, a request for reorganization or consolidation would need to be submitted to the Sacramento County LAFCo for review and approval. However, there are several aspects of the application that would need to be addressed. In addition, before an application is submitted, the two Districts would need to conduct public outreach and meetings with stakeholders.

The public outreach and meetings required by LAFCo represent part but not the entirety of recommended customer communications should SSWD and CWD take next steps towards a combination. As part of this Study, Raftelis developed customer engagement guidance for CWD and SSWD, which is included as Appendix F and touched on briefly in Section 6. It will be important for both organizations to communicate regularly about the combination process and potential options being considered. Developing resources like a fact sheet, infographics, or short videos, which can be used in different communications channels can help proactively address potential questions and drive people to learn more. Holding in-person or virtual open houses can be a good method to humanize the agencies and provide an opportunity for stakeholders to learn more about the process in a relaxed setting.

Sections 3.1.3.1 and 3.1.4 will address different aspects of combinations that the organizations will need to consider and that can inform the application to LAFCo.

3.1.3.1. Combination Process

Governance will be a key component of any effort toward combination. There are two avenues to combine the services of CWD and SSWD, consolidation or reorganization. The end result is essentially the same, with one agency assuming the rights, responsibilities, assets, and liabilities from the current organizations. Note that when we use the word combination, we are using that term purposefully to refer generically to any kind of combination of the agencies. Below are more details on the formally defined reorganization and consolidation scenarios:

- **Reorganization: Dissolution of CWD and annexation by SSWD** – One district is dissolved, and one agency annexes their former service area. Restructuring SSWD to merge with CWD would result in dissolving CWD. The SSWD Board would remain intact, as they were elected by the SSWD customers, however, there would need to be one Director from either SSWD or CWD that would resign, and then the Board would shrink from nine, to seven and finally to five, while redistricting the divisions at each election. This process would be included in the LAFCo resolution. The combined entity through this process would initially allow for a large Board consisting of a combination of SSWD and former CWD Board members. The Sacramento County LAFCo could assist and provide guidance in this process. Generally, this process is less disruptive than a consolidation and the protest period only applies to residents of the dissolving agency.
- **Consolidation: Creation of a new Water District** – All agencies are dissolved and a new one is created in their place with a service area that encompasses the previous districts' service areas. A new Water District would require dissolving both CWD and SSWD. According to interviews with LAFCo staff, LAFCo can approve a larger temporary Board to represent both CWD and SSWD Boards and allow the Board to become smaller over time until it reaches the size of five members, which seems to be a desirable size given the scope of the organizations and the service base. All residents from both districts can oppose during the protest period and may require a new Proposition 218 vote to re-ratify special taxes and benefit assessments (note this would not be relevant to CWD or SSWD revenues, as they are recovered through user charges). This process can be disruptive because it allows for the potential cancellation of existing contracts unless they are specifically transferred as part of the LAFCo approval.

To initiate the process, the Districts will need to submit resolutions of application to LAFCo which should include: the actions requests from LAFCo, designated contact person, map of the service area affected, what should be done with zones of benefit or benefit assessments, fiscal considerations, governing considerations, and any other conditions of approval requested of LAFCo. The Districts will work with LAFCo to review the combination plans and engage with the community. Regardless of the option chosen, formal notice will need to be sent to all landowners and registered voters within the boundaries of any district(s) being dissolved. An election to approve consolidation would be necessary if between 25-50% of registered voters or owners by land value object to the change. If more than 50% of registered voters or owners by land value object to the change, the consolidation will not go forward. If less than 25% of voters or owners by land value object to change the consolidation would go forward. In an interim period, assuming a consolidation moves forward, it will be important for both Boards to work closely together to identify the appropriate next steps, engage the community, and make decisions together.

Under either Reorganization or Consolidation CWD and SSWD may wish to work with LAFCo to create a temporary, larger Board with the desired number of members. This option allows all but one of the current

CWD and SSWD Board of Directors members to remain involved and roll off of the governance body as terms expire.

3.1.4. Prior Agreements

It is important to recognize that this Study and any subsequent steps towards combination represent the latest efforts in a measured and productive process of increasing regional collaboration for both CWD and SSWD. In the prior regional collaboration study extensive care was taken to document all that CWD, SSWD, and other regional peers already do to benefit from collective action. This includes joint metering contracts, trainings, and other events through the two state Joint Powers Insurance Authorities (CA JPIA and ACWA JPIA), regular coordination of conservation actions through RWA and beyond, mutual aid agreements, and beyond. While that study also identified additional steps to continue to advance successful collaboration, it was also clear that larger efforts held the potential for the greatest benefits. The LAFCo process is designed to confirm that before such a next step is engaged, residents have the opportunity to make their voice heard, but the agencies through their increasing success with collaborations have already demonstrated their collective will to pursue cost avoidance and service level optimization together.

3.2. Organizational Structure

The organizational structure of each agency is represented as the hierarchy of each agency's functional groupings and staff roles. Appendix A includes an organizational chart for CWD, and Appendix B the same for SSWD. In general, both agencies are organized into Management & Administration roles such as Executive, Finance, and Customer Services & Billing, as well as Engineering & Capital Improvement roles, Distribution System Operations roles, and Production Operations roles. While these similar structures suggest some level of redundancy in staffing, many of these functions will scale with any larger unified utility operation given the separate infrastructure components. Those roles that do not scale as easily in a combined structure can be absorbed through attrition if combination is pursued. Appendix C includes a proposed interim organizational chart that maintains all current staff as an initial structure, while Appendix D includes an example of a consolidated longer-term organizational chart that could be implemented over time. **Note:** The organizational charts should not be constructed as recommended structures or a roadmap for staffing. They are simply a conceptual approach showing how the two agencies could be combined in the short term and in the long term. Any decisions about how a combined entity may be structured is solely up to the leadership of the organization.

Noteworthy differences between the organizational structure of CWD and SSWD do go beyond just scale. As a result of the size of the organization, we also observe greater role specialization at SSWD relative to CWD. Rather than merely expanding the roster of generalists, larger organizations have the luxury of hiring a more specialized staff. These specialized roles are highlighted throughout the functional sections that follow.

One benefit of scale and specialization can be efficiency. Figure 4 and Figure 5 show that SSWD is able to serve nearly double the number of customer accounts and people per employee as compared with CWD. Since labor is a significant cost input for utilities, labor efficiency can lead to more affordable service as long as it doesn't result in declines in infrastructure reliability, an overworked staff, or other signs of an organization stretched thin. On balance, this Study does not suggest that SSWD is lacking in the provision of key services, but rather that, similar to the findings in the broader Collaboration Study which included additional utilities, SSWD is likely providing a high level of service at a relatively low cost. Section 5 digs

deeper into the finances of each organization to further assess potential performance and cost implications of combining agencies.

Figure 4: Customer Accounts per Employee

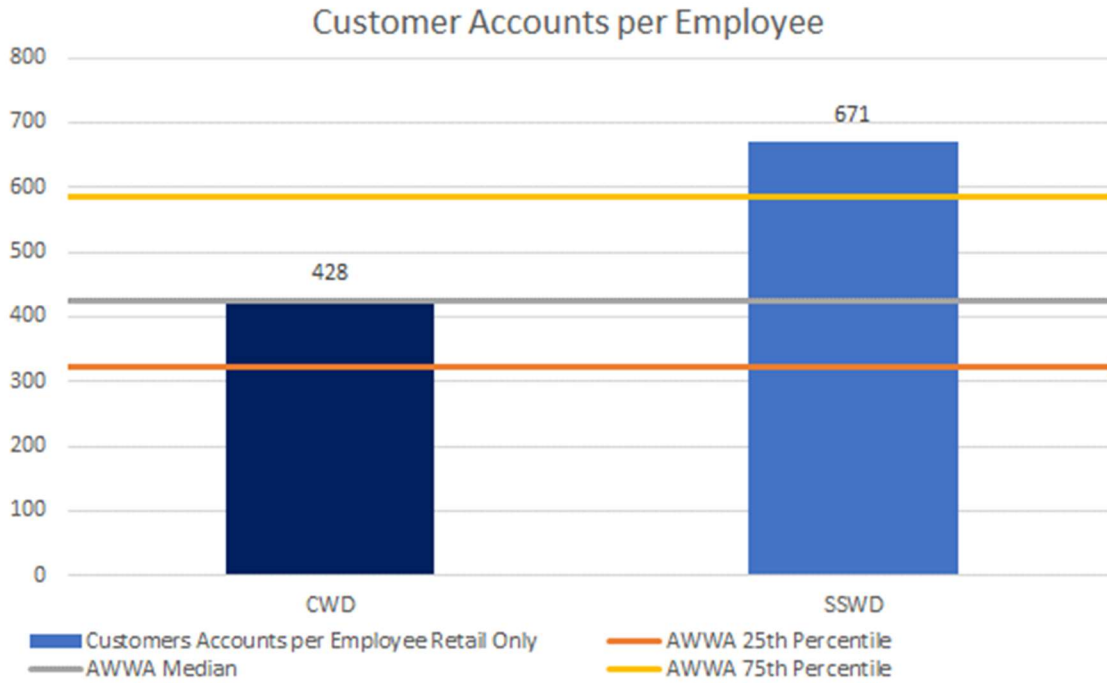
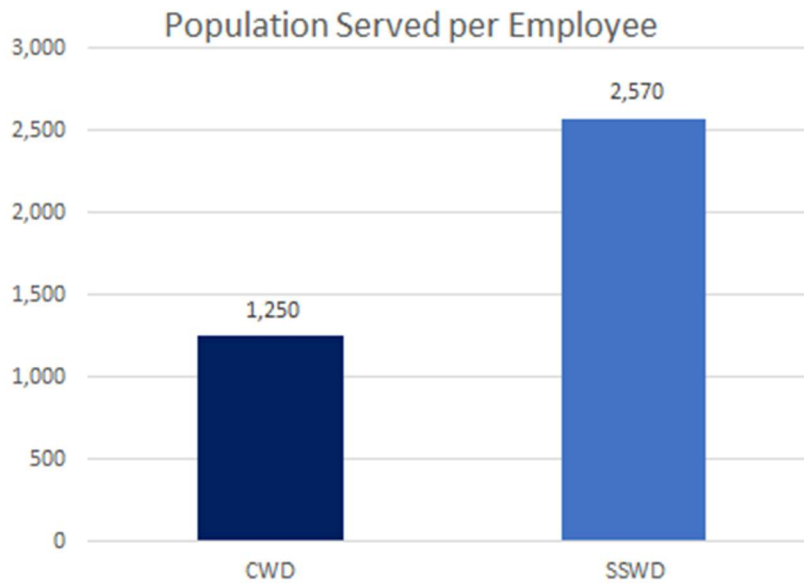

Figure 5: Population Served per Employee



3.3. Labor, Salaries, and Benefits

Due to differences in labor organization at CWD and SSWD, labor considerations must be addressed as part of any combined model. This section details the differences between the organizations and potential opportunities and challenges for the path forward. In addition to the level of organization, differences in salaries and benefits are important considerations as part of this assessment.

3.3.1. Labor Structure

CWD's Production and Distribution staff are members of the American Federation of State, County and Municipal Employees (AFSCME), Local 146, which is an affiliated union of the American Federation of Labor and Congress of Industrial Organizations (AFL/CIO) (the Union). The latest Memorandum of Understanding (MOU) between CWD and represented employees covers the period from July 1, 2022, through June 30, 2025. The MOU grants the Union the right to negotiate on behalf of represented employees across a broad scope of representation on labor matters, which include payroll specifications, leave time, schedule, breaks, salaries and wages, overtime, fringe benefits, grievance procedures, strikes and lockouts, disciplinary procedures, firing, health and safety, District policies, and job descriptions.

Broadly, many of the procedural items dictated by the MOU, such as mandatory breaks, and maximum work hours, may be distinct to CWD, but the resulting salary ranges and benefits do not shake out as extraordinarily different from SSWD, and in fact in many cases SSWD had higher salary ceilings for similar roles at the time data was provided for this Study.⁸ The key difference for represented CWD employees is that many of their employee rights are enshrined in an MOU, whereas at SSWD organizational procedures and policies may be more subject to the discretion of the Board/General Manager. Union membership dues are also a cost employees must weigh relative to the certainty of rights and benefits offered. Should CWD employees find that their peers at SSWD are well compensated and treated fairly vs. not, labor considerations may factor more or less into combination considerations.

SSWD employees are not represented by a union, and this presents a wrinkle that must be carefully considered in any move toward combining Districts. It might also be beneficial to consider timing and combination to align with the re-negotiation of the MOU between CWD and the Union. Ultimately, employees of CWD and SSWD would have to collectively decide with management as to whether or not they prefer to maintain representation or not under a combined agency. This decision depends of course on whether informal collaboration or full combination is pursued, but also on how a combination is pursued should it move forward. For example, if reorganization is pursued it is perhaps less likely that representation would be maintained, as SSWD being the larger agency and not currently having representation, could be less likely to accommodate terms and CWD would be dissolved. If, however, consolidation is pursued, the new agency would be starting from scratch and employees might jointly decide to join a union or not.

3.3.2. Salaries

The water sector finds itself in an increasingly competitive labor market where employee retention can be challenging. Both CWD and SSWD periodically conduct salary surveys to ensure that they remain competitive in the marketplace.

⁸ Note that CWD had salary adjustments during the Study that may have resulted in more parity but observations detailed here reflect data provided earlier in the Study.

Appendix D details the salary ranges for each role at both CWD and SSWD. For 2022 SSWD has a higher average salary (\$91,093) and median salary (\$81,151) as compared with same for CWD (\$74,947 and \$67,941 respectively). Still CWD notes that salaries for represented employees at CWD are similar to the most comparable positions at SSWD with largely overlapping ranges depending on the level following adjustments that occurred during the Study after data was analyzed. It is important to note that the CWD fiscal year is offset from SSWD's calendar year, and therefore costs of living adjustments may lag CWD, particularly during the current period of exceptionally high inflation. It is also common for smaller agencies to pay lower salaries given that their base of ratepayers (colloquially "ratebase") is smaller. This can be significant in terms of employee retention and recruitment and is clearly one argument in favor of combining agencies.

As water agencies get larger, in general, there are more opportunities for advancement and specialization in roles, whereas at smaller agencies employees may wear many hats. At the same time smaller organizations may allow employees to have more involvement in decision making and less bureaucracy, which some may find desirable. While the workplace environment is an important determinant in employee retention, for many a baseline expectation is that the paycheck is at a minimum competitive if not above market rates for a given role. As discussed above, organized labor also influences agency salary setting and may dictate ranges, levels, overtime, hours, and other important terms that may be critically important for represented employees.

In general, a comparative review of salaries might suggest that some CWD employees might expect a raise if they were reorganized (note we are using the word "reorganized" very definitionally here) into SSWD, however, the salary tradeoffs in a new consolidated (note we are using the word "consolidated" very definitionally here) entity could be less clear and involve potential tradeoffs and re-negotiations. Part of the challenge of projections about salaries in any combination model is that employee roles and responsibilities might change under varying approaches, with some employees' responsibilities narrowing and increasing in specialization and others potentially broadening over the larger service area of number of customers/employees. These potential changes also vary by role as, for example, the job responsibilities of Treatment Operators at CWD might not change very much under a combined agency where they are focusing on infrastructure that is unique to the CWD system (Bajamont Water Treatment Plant). However, Distribution Operators at CWD could potentially be merged into a larger team where resources might be deployed across a combined service area, therefore theoretically expanding the territory and complexity of such roles.

Some CWD employees believe there are benefits from the advocacy activities of their Union in salary negotiations and the step and CPI increases that are negotiated into the MOU on their behalf will be important considerations for some represented staff even if at present the resulting salary ceilings of those roles appear lower than some equivalent roles at SSWD.

Of course, salaries are only part of the total package of employee considerations with the other major component being the range of benefits.

3.3.3. Benefits

Particularly in the United States employees rely on their employer for not just income, but also a range of benefits that ensure their well-being in other ways. While medical insurance is the most prominent, there is a much broader spectrum of fringe benefits and paid time off nuances that tend to vary by employer. As with salaries, some aspects of benefits may be impacted by collective bargaining agreements for applicable represented employees at CWD.

Broadly, the agencies' benefits appear quite comparable. Each offer a similar range of benefits with reasonable employer contributions for insurance premiums, though contribution levels do differ with CWD contributing more to offset healthcare premiums⁹. Similarly, retirement benefits are dictated largely by a state program, the California Public Employees Retirement System (CalPERS), are therefore appear analogous as well. Again, represented employees at CWD may hold tightly to the benefits that their Union offers should representation be on the table in any combination considerations.

Note that CWD does not have benefits policies for part-time employees as they generally do not have any on staff, while SSWD part-time employees are not offered benefits and again there is no policy.

Table 1: Benefits Summary

Benefit Type	CWD	SSWD
Medical	Provided to all regular FT and eligible retired employees. New employee eligibility is discussed during orientation with waiting periods varying by plan. District pays premium for employees and eligible dependents up to Blue Shield Access Plus – Region 1 rate for each plan.	Provided to all regular FT and eligible retired employees (per CalPERS for retired the 10/20 vesting schedule applies). New employees are eligible on 1st day of first full month following hire date.
Dental	District pays dental premiums for all employees and eligible dependents.	District pays dental premiums for all employees and eligible dependents. New employees are eligible on 1st day of first full month following hire date.
Vision	District pays vision premium for all employees and eligible dependents.	District pays vision premium for all employees and eligible dependents. New employees are eligible on 1st day of first full month following hire date.
Basic Life and AD&D	The District pays premium employee's Basic Life/AD&D. The amount of the Basic Life/AD&D benefit is equal to two (2) times the employee's annual base earnings up to a maximum benefit of two hundred thousand dollars (\$200,000).	Fully paid life and accidental death insurance benefits equal to 2 times annual salary (uncapped) are effective the first day of the first full month following hire date; coverage is available for active employees only.
Short Term Disability	N/A?	Fully paid short-term (STD) disability insurance benefits are effective the first day of the first full month following hire date; coverage is available for active employees only. STD is 66.67% of basic weekly income to a maximum benefit of \$2,000 and begins on the 31st day of disability up to a maximum of 9 weeks.
Long Term Disability	District pays premium for employee.	Fully paid long-term (LTD) disability insurance benefits are effective the first day of the first full month following hire date; coverage is available for active employees only. LTD is 66.67% of basic monthly income up to a maximum of \$10,000.

⁹ Costs of medical benefits per employee indicate that CWD pays about \$1,000 more per employee per year in support of premiums. Indeed CWD notes that their employees generally do not pay out of pocket premiums.

Deferred Compensation	Voluntary IRS approved 457 plan available. Employee eligible to enroll upon date of hire and may change contribution amounts of percentage at end of any pay period. District makes no contribution or match.	Voluntary plan, two separate IRS 457 plans available. Employee eligible to enroll upon date of hire and may change contribution amounts of percentage at end of any pay period. District makes no contribution or match.
Retirement	CalPERS years of service takes effect immediately upon employment. As required by CalPERS, new members (after 1/1/2013) must pay the employee share for the 2% @ 62 benefit and at CWD 50% of the normal costs. Classic Members (prior to 1/1/2013) are eligible for the 2% @ 55 plan and the employer portion only is covered.	CalPERS years of service takes effect immediately upon employment for FTE's. As required by CalPERS, PEPRAs members (CalPERS membership after 1/1/2013) must pay the employee share for the 2% @ 62 benefit. Classic Members (CalPERS membership prior to 1/1/2013) are eligible for the 2% @ 55 plan and the employer portion is covered for those Classic employees hired before 8/18/2020. Classic Members who are hired after 8/18/2020, must pay the employee share for this benefit as well. Classic members who were hired before 1/1/2003 are eligible for the 3% @ 60 formula, and the employer portion is covered. This plan is closed.
Retiree Health Coverage	The District will provide medical coverage for Retirees and eligible family members based on the CalPERS medical benefits vesting schedule. The retired employee is responsible to coordinate all retirement and retiree medical benefits with CalPERS within the applicable timeframes and contract requirements.	Employees hired on or after 1/1/03 who retire from the District with at least 5 years of service and a minimum of 10 years credited service in CalPERS are eligible for post-retirement medical benefit payments up to the higher of: the higher of the lowest-cost HMO or PPO plan offered by CalPERS, or the CalPERS "100/90 Formula." The District's contribution toward post-retirement coverage for employees and their eligible dependents will be a percentage of the post-retirement coverage cost based on the employee's total credited years of qualifying service under the CalPERS vesting schedule. Those employees hired before 1/1/2003 are considered fully vested.
Holidays	11 holidays plus one floating holiday	13 paid holidays per year – if less than 13 are designated by GM, personal holidays are received in order to reach the total of 13.
Vacation	Full-time employees accrue time each pay period based on length of service to District, earning from 12 to 25 days per year. An employee may cash out up to the maximum vacation accrual (300 hours) upon separation.	Similar to CWD; An employee may accrue a max of 400 hours (hours over cap are paid out on December each year) and will be paid for all unused vacation at separation of employment.
Sick leave	FT earn 3.7 hours of sick time per pay period (12 days or 96 hours per year)	12 days per year (96 hours) per year beginning the first full pay period after hire date.
Bereavement Leave	Yes	Yes. Currently 3 paid days with allowance for extra 3 days using employees own leave balances. In process of possible change in language due to AB 1949, which requires employers to offer 5 (unpaid) days of bereavement.

3.4. Management & Administration

CWD and SSWD have management and administration staff to provide valuable enterprise-wide services such as executive leadership, human resources (HR), finance, accounting, customer service, billing, information technology (IT), communications, inventory, and water conservation that support the core function of water provision. In this section we will review the management and administration implications of combined management & administration operations.

3.4.1. Utility Comparison

Management and administration activities at CWD include general management, finance, accounting, payroll, inventory, purchasing, billing, customer service, water conservation, communications, and HR functions. In terms of reporting, CWD houses their communications and water efficiency staff, as well as their Information Technology Coordinator under the Engineering Manager. The latter roles will be discussed in this section as they are more typically considered a higher-level management and administration function. Engineering roles including GIS are discussed in Section 3.5. In total CWD management & administration staff includes 12 staff roles or full-time-equivalents (FTEs) all of which are non-union positions. CWD management and administration staff job descriptions, FTEs by role, reporting relationships, and exempt status are summarized as follows:

- General Manager (GM) (1, Reports to Board) – The GM is the agency executive leader and Board liaison. All management level roles at CWD ultimately report to the GM; the GM directs and reviews the overall activities and operations. This is the only role that does not have a defined salary range as GM compensation is by contract. This is a salaried exempt position.
- Administrative Specialist (1, Reports to GM) – The Administrative Specialist conducts a range of administrative work in support of the GM and Board, under the general supervision of the GM. Specific responsibilities include organizing and coordinating Board related functions, HR operations, preparing reports, and other duties as assigned. Note that CWD does not have any in-house HR staff. This is a salaried exempt position.
- Finance Manager (1, Reports to GM) – The Finance Manager plans, organizes, manages, coordinates, and directs the financial and business operations. This is a salaried position.
- Inventory Specialist (1, Reports to Finance Manager) – The Inventory Specialist is responsible for purchasing, warehouse and inventory management, facility maintenance, and meter reading. This is an hourly (non-exempt) position and is eligible for overtime.
- Senior Accountant (1, Reports to Finance Manager) – The Senior Accountant performs a variety of fiscal, payroll, and recordkeeping operations. This the higher of two levels of accounting roles each with their own salary bands to encourage advancement. This is an hourly position and is eligible for overtime.
- Billing Supervisor (1, Reports to Finance Manager) – The Billing Supervisor manages the billing operations and oversees interactions with critical billing software (CSM, Great Plains) that are fundamental to issuing bills to customers and ensuring revenue recovery. In addition, the Billing Supervisor and their direct reports handle customer service interactions and complaint responses. This is an exempt position.
- Billing Specialist (2, Report to Billing Supervisor) – The Billing Specialist completes workloads assigned by the Billing Supervisor. Tasks focus on billing water services, accounts receivables, and customer service. There are two levels to this role each with their own salary bands to encourage advancement. This is an hourly position and is eligible for overtime.

- Information Technology Coordinator (1, Reports to Engineering Manager) – The IT Coordinator manages the computer, telephone, security, communication, and IT functions of the District. This is a salaried position.
- Public Information (PIO), Water Efficiency, and Communications¹⁰ (3, Report to Engineering Manager) – Public Information, Water Efficiency, and Communications staff manage the public information, water efficiency, and new construction operations of the District. Junior staff tasks include monitoring and analyzing consumer water use to ensure compliance with conservation requirements and best management practices, as well as being involved in the meter reading program. The PIO is an exempt position, and the rest are non-exempt.

Management and administration activities at SSWD include general management, finance, accounting, payroll, inventory, purchasing, billing, customer service, water conservation, communications, IT and HR. In terms of reporting, SSWD includes a GIS and Engineering Drafter under the management and administration branch of the organizational chart.¹¹ Those roles will be discussed in Section 3.5. Further, SSWD has an Assistant General Manager role that is more focused on management of engineering and system operations but is included here given the leadership role this position occupies. In total SSWD management and administration staff includes 26 staff roles or FTEs. SSWD does not have any staff that employ collective bargaining. SSWD Management and Administration staff job descriptions, FTEs by role, reporting relationships, and salaried (exempt) status are summarized as follows:

- GM (Reports to Board) – The GM is the agency executive leader and Board liaison. All management level roles at SSWD ultimately report to the GM, as the GM directs and reviews the overall activities and operations of the District. This is the only role at the District that does not have a defined salary range as GM compensation is by contract. This is a salaried exempt position.
- Assistant GM (1, Reports to GM) – The Assistant GM sits atop the engineering and operations divisions of SSWD and serves as an operations leader. This is a salaried exempt position.
- Executive Assistance to the GM (1, Reports to GM) – The Executive Assistant to the GM conducts a range of administrative work in support of the GM and Board under the general supervision of the GM. Specific responsibilities include organizing and coordinating schedules, preparing reports, overseeing Board policy reviews, and other duties as assigned. This is a salaried exempt position.
- HR Administration (2, Report to GM) – The Human Resource division oversees all HR operations for the District including recruitment, salaries and benefits, and employee relations while ensuring compliance with applicable local, state, and federal laws that govern these personnel activities. This is a salaried position. In addition, HR staff receive and respond to inquiries from the public, other District departments, and outside agencies and assists with various special projects.
- Finance and Administration (5, Reports to the GM) – The Director of Finance and Administration leads a team of five that deliver finance and accounting services at SSWD. The Director reports to the GM. In addition to the Director, staff roles include an accounting Controller as well as two additional accounting staff. A Purchasing Specialist role also serves as a management and administrative role related to the financial group, though their focus is much more on the operational realm of the organization. In addition to accounting, responsibilities include budgeting, rate setting, internal financial reporting, and beyond.

¹⁰ CWD noted during the Study that the Communications role is no longer on staff.

¹¹ These were recently moved to the IT department by SSWD for efficiencies.

- Billing and Customer Services (6, Reports to Director of Finance and Administration) – The Billing and Customer Services staff handle critical functions for SSWD that include processing bills/collections, and handling customer inquiries. This division also sits under the Director of Finance and Administration. This dedicated function serves as the face of the utility for many customer interactions and includes staff with a broad set of resources and procedures that support their ability to handle a wide range of customer requests that may touch on service issues, billing, conservation programs, complaints, and beyond. Ensuring adequate staffing and responsiveness in this division can significantly impact perceptions about any public utility.
- Water Conservation (2.5, Reports to Customer Services Manager) – The Water Conservation division at SSWD includes general public information, communications, and dedicated water efficiency staff. This group manages conservation programming and efforts to inform the public about the full range of utility activities, resources, and events. SSWD notes that there are two temporary roles hired as seasonal staff in summer. These are reflected here as 0.5 FTE.
- Information Technology (3, Reports to Director of Finance and Administration) – The Information Technology division ensures that key electronic systems and tools are functioning to meet the needs of utility staff and operations cross functionally.

In addition to the roles listed above, SSWD on occasion employs Temporary Office Staff or Interns in support of various management and administration functions. These positions are paid hourly and do not receive benefits.

3.4.2. Opportunities

The management and administration functions are the areas of the organizations that may present the largest potential overlaps in roles under a combined agency. Even at large organizations, it is sometimes possible for executive level functions to be staffed relatively leanly given their job descriptions. However, any identified redundancies are likely best addressed through attrition and over time to ensure a smooth transition to any new organizational framework due to certain challenges that can emerge when attempting such a transition. These challenges are described in the section below. This concept will also be discussed more fully in Section 7.

In addition to opportunities to achieve leaner executive level staffing under a combined organization, management and administration functions may benefit from certain roles that either currently do not exist, or may be somewhat over- or under-staffed, at one organization or another. Specifically, the following opportunities are apparent as we look across CWD and SSWD:

- CWD does not have a dedicated HR staff, and SSWD does. CWD could benefit from this resource for recruiting and other critical HR functions.
- For its size, CWD is well staffed in water conservation and communications functions. If combined with SSWD it's possible that some staff in these areas could perhaps be realigned or reduced through attrition over time, or changes made in responsibilities to increase specialization.
- The CWD Inventory Specialist is involved in a range of functions including meter reading and appears to have some overlap in responsibility with SSWD's Purchasing Specialist role. It could therefore make sense to specialize these roles further under a combined organization to allow employees to deepen their focus on elements of the tasks that they excel at or might prefer to focus on.
- There would likely need to be a layering of responsibility between the two GM roles under a combined organization. This could perhaps initially be achieved through the creation of a Deputy role

or a division of responsibilities and focus between the two employees. Over time it is expected that these high salary positions would collapse into one position through attrition.

- Existing contract legal savings of up to \$1.28 million could be realized over 10 years if annual costs are halved.

Note: These are merely suggestions that could be implemented in a combined organization to increase efficiency or effectiveness. Any decisions about how a combined entity may be staffed or structured is solely up to the leadership of the organization.

3.4.3. Challenges

Seizing opportunities for potential savings by realigning or reducing staffing in management and administrative functions is typically not straight forward for a number of reasons:

- A larger organization does require more overhead staff to manage the larger system and headcount. It may also need to meet new requirements because of its size that smaller organization were able to avoid.
- A combined agency that merely seeks to cut staff to save on costs could hurt the morale of existing employees and lead to a significant loss of organizational knowledge. Staff cuts could also jeopardize the existing levels of service stakeholders have become accustomed to receiving.
- Whether CWD or SSWD staff take on leadership or managerial roles in any newly combined framework, and particularly where they are involved in work that crosses the old service area boundaries, there are likely to be gaps in knowledge about the staff, IT, procedures, and infrastructure that they are newly responsible for. Where reporting relationships change it may take time for staff to build trust with each other.
- There are some positions at each organization that are currently taking on multiple roles and may at times be stretched thin. In a combined organization, those serving multiple roles could hand off those tasks that are outside their core job description to more specialized staff. This would allow them to undertake their core job description at a deeper level with the goal of delivering a more comprehensive level of service to the organization.
- Differences in accounting, finance, billing, and metering technologies may take time to reconcile and require investment as systems integration will be key to realizing the full operational benefits of combining the agencies.

Section 7 details a possible path forward to help mitigate these challenges through a phased combination approach.

3.5. Engineering

Engineering and capital planning/delivery functions are critical to water systems given the need for planning and the design, renewal, and replacement of physical assets to ensure reliable services for customers. At some utilities the bulk of the engineering and planning is performed by outside consultants and at others more of these functions are performed by staff. SSWD and CWD perform a considerable amount of engineering and capital planning/delivery functions in-house, but use consultants for more complex projects. Key staff members at SSWD and CWD often collaborate with a range of consultants and contractors to conduct a complex and temporarily variable set of major projects over time. In this section we look at the structure of the engineering functions of CWD and SSWD to identify opportunities and challenges that might result from the combination of these staffs into a single area-wide function.

Finally, in the digital age a key collaborator with engineering departments and other utility functions has become in-house GIS and Computerized Maintenance Management System (CMMS) experts. These technologies allow utilities to create work/service order records, maps, and digital twins of their systems to aid in tasks ranging from work planning and asset management to system design, locating, record-keeping, asset management, and beyond.

3.5.1. Utility Comparison

At CWD a small engineering department (3 FTE) handles this key function with contractor support, as needed. As we observed with the management and administration function, the relatively lean engineering department staff at CWD are expected to handle a broad range of activities. The Engineering Manager Reports to the GM and supervises one staff Engineer, as well as a GIS Specialist role. Together this team handles capital project management, infrastructure design with contractor support, capital planning assessments and development, asset management planning, compliance reviews, and the full range of engineering functions.

At SSWD the larger engineering department (8 FTE) is able to specialize more as compared with that of CWD. For example, SSWD employs a full-time Engineering Drafter (1 FTE) to help develop technical drawings based on the designs, plans, and layouts of engineering staff.

SSWD employees three Student Interns in support of various engineering functions. These positions are paid by the hour and do not receive fringe benefits.

3.5.2. Opportunities

In the SSWD Engineering Department, we observed the greater level of specialization and role hierarchy that SSWD's scale offers. Employees that are responsible for more roles simply are not able to focus as much effort and may be less proficient at each task than those in more specialized roles. However, per more granular analytics that are consistent with Figure 4 (not included in Report) we also know that engineering employees at SSWD are responsible for more accounts per employee than those at CWD, which takes the efficiency of specialization and works to stretch it further.

Around the country staff at utilities tend to be quite busy, due to an aging and competitive workforce and skilled labor shortages. Ultimately, it will be up to local management at any new entity to determine if current available staff numbers are insufficient, adequate, or perhaps excessive in a given function. Current vacancies across the two engineering departments may be able to be filled by existing staff as roles change or are eliminated and as the synergies of the combined organizations become clearer.

3.5.3. Challenges

Combination of the engineering departments may present the following challenges:

- Both organizations have Engineering Manager roles that could be maintained under an interim structure with each of their focus directed at specific activities. SSWD notes that this is what was done when Arcade and Northridge came together, and a similar redundancy was identified.

- Despite being staffed with capable engineers and technical people, each organization has distinct CMMS and GIS procedures¹², and practices that can be difficult to integrate. These decisions will take time and require focused decision-making, leadership, and governance. The spirit of collaboration and trust required to fully align disparate sets of experts, each of which know their own systems better than the other, will take time to cultivate.

Section 7 details a possible path forward to help mitigate these challenges through a phased combination approach.

3.6. Field Operations

The field operations of the agencies include activities focused on the water distribution infrastructure of CWD (9 FTE) and SSWD (24 FTE). In addition to division managers and operational staff, field operations at SSWD also include dedicated roles for safety, fleet management, distribution related facilities, and field operations coordination. The water distribution infrastructure of CWD and SSWD are not anticipated to contract with the potential organizational combination under consideration. Unlike management and administrative structures that may be refined through a combination, the distribution staff of the two organizations is not likely to be an area where obvious efficiencies present in the interim, particularly below the managerial level. While current vacancies that exist in the workforce could potentially be eliminated under a combination, management will likely only be able to determine if efficiencies have emerged once the workload and staff availability of the combined organization becomes clearer. Nationwide, water utility operational staff are becoming harder to find and so it is likely the focus will be on retaining and recruiting.

3.6.1. Utility Comparison

CWD field operations include a superintendent and eight operational staff including vacancies. These staff are included in the union contract. At SSWD there are 23 field staff positions including vacancies. The fully staffed organization would include distribution facilities and fleet specialist roles as well as a field operations coordinator in support of the Operations Department. Finally, an existing Safety/Risk Officer role at SSWD straddles the definition of management and administration and operational staff as they sit in an oversight role, but interact significantly with field staff on compliance requirements and internal policies designed to ensure their safety.

3.6.2. Opportunities

A combination of the field operations staff could present the following opportunities:

- A key benefit of the larger workforce will likely be the increased flexibility that comes with having more resources to deploy on days when some staff may be unavailable. This alone should increase operational reliability in both service areas. Overtime work can also be spread out somewhat further to reduce the potential for staff burnout and help cover position vacancies.
- Knowledge sharing between the staff of each District can ensure that best practices permeate each District. This can be accelerated further through joint training. The SSWD training facility is already

¹² Both agencies use ESRI ArcGIS, the same tool, but each may have different standards and procedures for mapping assets and leveraging data in the field, at facilities, and via integrations with CMMS tools. Overtime the sophistication and integration of this information can be operationally powerful and tends to scale with utility size to enable increasing coordination and asset management best practices.

an asset that presents regional training opportunities, but it can be exploited further should the agencies combine.

- Equipment sharing and joint purchasing can also accelerate under a combined organization, particularly if joint facilities are invested in. For now, a centralized distribution deployment and warehouse facility is not contemplated as a near term priority for the combination effort, but over the longer term consolidated real estate could advance at the discretion of the Boards and management.
- The field operations staff could likely maintain split Superintendent roles in the interim structure before being combined into one deployable force with a single Superintendent in the future. If teams dedicated to each service area are justifiable given the differences in the infrastructure and geography of the systems, the teams can be kept largely separate except where staff are exchanged to meet any increased workloads for projects periodically or where staff are used to fill in for vacations or absences here and there. This arrangement could be adjusted once more operational experience with the combined system is gained and particularly if infrastructure, expertise, and procedures begin to become more homogenous across the two service areas.
- Larger organizations are perceived to have better staff retention as well as more opportunities for advancement, learning, support, and team building emerge in mature organizations, which are also more resistant to competitive wage pressures.

3.6.3. Challenges

Combining the field operations staff could present the following challenges:

- The distinct infrastructure, practices, and familiarity of each District may lead to a period where it is initially challenging for best practices and joint senior management to realize fully efficient combined field operations.
- Differences in infrastructure between the systems may also limit opportunities for joint purchasing of materials and supplies or equipment where it is not practical to align them over time based assets lifecycles and the needs of each service area.
- CWD collective bargaining will be challenging to navigate under any combined organization. Under a reorganization where CWD merged into SSWD, the union contract may be voided as it would through a consolidation where both Districts initially dissolve. However, under any scenario field operations staff would have the opportunity to organize as is the case at any District currently.

Section 7 details a possible path forward to help mitigate these challenges through a phased combination approach.

3.7. Water Production Operations

There are important differences between the water production and treatment operations of CWD and SSWD. Most prominent is that CWD staff operate a surface water treatment plant that requires daily staffing, and that has 20.5% cost offsets as part of the Golden State Water Company/Aerojet Rocketdyne agreement. Staffing for the CWD plant dictates certain role requirements and certifications relative to groundwater

productions staff, who often work less regular and more mobile schedules while servicing numerous groundwater production sites.

3.7.1. Utility Comparison

CWD water production staff include a superintendent and five additional certified water treatment operators for the 22 million gallons per day (MGD) Bajamont Water Treatment Plant. These staff are included in the union contract. At SSWD, water production staff (17 FTE) include more layers (superintendent, foreman, and operators) and add dedicated instrumentation and SCADA roles that are critical to the functioning of the larger system.¹³ SSWD's compliance and cross connection staff sit here as well, as their work touches on policy, lab work, and sources of supply. Environmental Compliance roles (3 FTE) at SSWD work to ensure the system and operations are aligned with applicable regulations from all levels of government. An SSWD Cross Connection Control Specialist (1 FTE) reflects further operational specialization at SSWD. However, it is due to licensing and certification requirements that CWD does not have dedicated compliance or cross connection positions, though more general staff and contractor support are employed to ensure that these tasks are addressed. This is, in fact, due to operator requirements at the water treatment plant.

3.7.2. Opportunities

A combination of the water production operations will present the following opportunities:

- Some of the functions detailed here, such as the Environmental Compliance, and Cross Connection roles are organized differently for CWD due to specialty surface water treatment plant requirements and smaller customer base. The implications of having dedicated staff in these areas may in theory be significant for groundwater portions of CWD and include avoided contractor costs, increased expertise, and greater degrees of specialization on assigned tasks. However, for the operations of the water treatment plant at CWD, the specialists at SSWD may not be available or necessary given the unique skill sets CWD plant staff.
- Because the water supplies of CWD and SSWD are separated spatially and by the type of supply and nature of treatment operations, these facilities are expected to remain separate. This reduces the amount of capital investments that are needed as part of the combination and minimizes disruption to operations in these areas.
- Despite differences in the systems, it is expected that some materials and supplies, equipment, or even staff or contracting will be able to be shared for the groundwater portions of the system under a combined organization to the benefit of each agency.
- SSWD roles dedicated to SCADA could perhaps benefit CWD. Generally “smart-water” and “internet-of-things” investments and costs may scale favorably as a larger combined organization
- Fundamentally, combination will result in a more diverse and resilient water supply.

3.7.3. Challenges

A combination of the water production operations will likely present the following challenges:

- Restrictions on surface water adjudication may limit the use of shared treatment infrastructure. Were these restrictions not present, an engineering feasibility study to look at a truly combined production infrastructure could perhaps proceed to maximize efficiencies in water production operations.
- The differences in the systems may limit the amount of shared expertise and the ability to leverage the larger organization under a combination.

¹³ SSWD notes that SCADA staff was moved to IT from Operations during the course of the Study.

- CWD collective bargaining will be challenging to navigate under any combined organization for water production staff. Under a reorganization where CWD merged into SSWD, the union contract may be voided as it would through a consolidation where both Districts initially dissolve. It is generally only under a reorganization where SSWD dissolved and was annexed by CWD where the union would remain. However, under any scenario production staff would have the opportunity to organize as is the case at any District currently.

Section 7 details a possible path forward to help mitigate these challenges through a phased combination approach. Finally, note that more detail on water supplies is discussed in a separate section of the report.

4. Water Resources

This section (authored by Raftelis partner Zanjero) examines the fundamental issues associated with using each District’s water assets under a combined governance model and explores approaches to water asset management integration in the context of changed future climatological and regulatory conditions. Currently, both SSWD and CWD possess ample surface water and groundwater supplies to meet their current needs and both Districts provide reliable water supplies even under extreme drought cycles as experienced over the last ten years.¹⁴ But, there are changing water supply reliability concerns within CWD and SSWD as snowpack and runoff patterns from the Sierra Nevada mountains change, Placer County and the City of Sacramento experience extended population growth, and regulatory requirements in the Sacramento-San Joaquin Bay Delta (Delta) address water quality and endangered species concerns. For example, CWD experienced no surface water right curtailments in its 100-year history prior to 2014. Since 2014, CWD has experienced water right curtailments and serious threats of water right curtailments in four of the last ten years through August 2022.¹⁵

The changes in water supply patterns are happening and likely caused by regulatory modifications and climate variation throughout the Sacramento River watershed drainage.¹⁶ Previously unknown curtailment orders have been issued for appropriative water rights with priority dates as old as 1852 in the American River watershed.¹⁷ And surface water supplies that are needed to stabilize the saltwater intrusion into the Bay-Delta estuary (known as the “X2 Line”) as well as threatened and endangered species populations in the Delta and its tributaries will require additional flows derived from existing water rights. As such, creative approaches will be needed to optimize the water assets available to CWD and SSWD through any combination process to ensure supply availability over an extended water planning horizon.

4.1. CWD and SSWD Water Asset Inventory

CWD possesses numerous surface water supplies and groundwater wells. CWD also has access to additional surface water supplies that it has not yet fully activated. SSWD obtains its water supplies from groundwater extraction and surface water supplies delivered under contracts with neighboring water agencies. All of these supplies could be integrated to maximize benefit for both Districts through a combination effort.

4.1.1. CWD’s Surface Water Rights

CWD’s primary water supplies consist of three appropriative water rights derived from the natural flow of the American River – License 1387, License 8371, and Permit 7356. The “natural flow” consists of supplies that would normally be available on the river system under natural conditions subject to more senior appropriators. For instance, CWD’s water rights are senior in priority to the United States Bureau of Reclamation’s (Reclamation) water rights for Folsom Dam and reservoir.¹⁸ As such, CWD has the right to

¹⁴ The cost to provide each source of water is an important factor in optimizing future water deliveries but is ancillary to the reliability issues posed in this assessment.

¹⁵ On August 16, 2022, SWRCB issued a curtailment order for CWD’s License 1387 interrupting CWD’s groundwater substitution transfer.

¹⁶ <https://resources.ca.gov/-/media/CNRA-Website/Files/Initiatives/Water-Resilience/CA-Water-Supply-Strategy.pdf>

¹⁷ State Water Resources Control Board Curtailment Order of August 3, 2022.

¹⁸ Reclamation’s oldest water right on the American River is Application 13372 with a priority date of October 1, 1949.

divert the natural flow in the American River watershed to fill its water supply needs before Reclamation may divert any water to meet its storage rights in Folsom Reservoir because of the priority in water right appropriations.

CWD’s supply is based upon water availability that is tied to CWD’s three diversion priority dates under its water rights of 1915, 1925, and 1948. The State Water Resources Control Board (State Board) determines when there is sufficient water supply in the American River watershed to satisfy CWD’s diversion rates under each water right. The State Board’s supply availability analysis relies upon hydrologic models that simulate water diversions throughout the American River watershed based upon snowpack surveys and streamflow measurements. Table 2 summarizes the key components of CWD’s three surface water rights.

Table 2: CWD’s Surface Water Rights

Water Right	Priority	Div Rate	Volume (AFY)	Div Period	Purposes of Use	Place of Use	Status
L-1387	9/18/1915	15 cfs	10,859	Jan - Dec	Irrig and Dom	4500 AC, Map 1964	Active
L-8731	8/22/1925	10 cfs	3,669	May - Nov 1	Irrig, Dom, and Mun	4500 AC, Map 1968	Active
P-7356	3/1/1948	25 cfs	18,099	Jan - Dec	Dom and Mun	4500 AC, Map 1968	Pending

cfs = cubic feet per second, AFY = acre-foot per year

As shown in Table 2, CWD’s three surface water rights present a number of unique attributes that require explanation and further consideration. First, the total diversion rates under each water right are permitted only during specific periods in a calendar year. License 1387 and Permit 7356 may be diverted in all months of the year but License 8731 may only be diverted from May 1 through November 1 of each year. Figure 6 below shows the monthly diversions available under each water right for each month of the year.

Figure 6: Diversion Rates for CWD’s Water Rights¹⁹

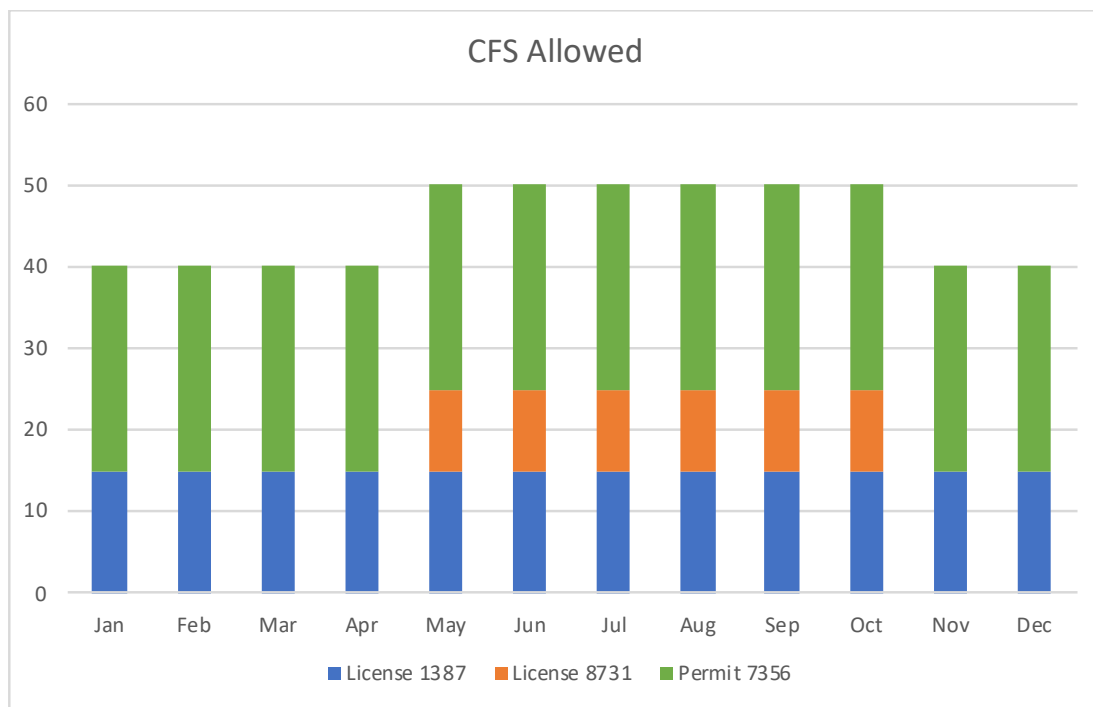

¹⁹ Carmichael Water District 2020 Urban Water Management Plan at page 3-2.

As shown in Figure 6, CWD has significant water supplies available in each month under all three of its water rights, assuming there are no monthly curtailments and that the water supply noted under Permit 7356 is available. Specifically, the minimum water available per month exceeds 2,000 acre-feet in February and the maximum monthly water available exceeds 3,000 acre-feet in the summer. On an annual basis, as shown in Table 2, CWD's surface water volume totals 32,627 acre-feet. Although this total volume is tantalizing, the actual available annual supply is likely less than this total, and in some months, as seen in the curtailment orders issued over the last 10 years, may be reduced to zero.

There are three beneficial uses assigned to CWD's three water rights. All water rights are available for "domestic use", while Licenses 1387 and 8731 may also be used for "irrigation" and License 8731 and Permit 7356 are available for "municipal use." These beneficial uses are defined more specifically as follows:

- Domestic Use: "...the use of water in homes, resorts, motels, organization camps, campgrounds, etc., including the incidental watering of domestic stock for family sustenance or enjoyment and the irrigation of not to exceed one-half acre in lawn, ornamental shrubbery, or gardens at any single establishment. The use of water at a campground or resort for human consumption, cooking or sanitary purposes is a domestic use."²⁰
- Irrigation Use: "any application of water to the production of irrigated crops or the maintenance of large areas of lawns, shrubbery, or gardens."²¹
- Municipal Use: "the use of water for the municipal water supply of a city, town, or other similar population group, and use incidental thereto for any beneficial purpose."²²

Starting with 2022 water rights reporting, CWD is able to use its monthly billing data, based on customer type to differentiate the delivery of its water supplies based upon the beneficial use classifications. For instance, for 2022 reporting, CWD identified that the surface water delivered to a supermarket is derived only from License 8731 or Permit 7356, since a supermarket may not be considered a "domestic use" or "irrigation use" under the California Code of Regulations. Specifically, there is the potential that a supermarket in CWD's service area may not be eligible to use a water supply derived from License 1387 in the event that purposes of use enforcement actions impact CWD.

The availability of CWD's water rights also have place of use restrictions – meaning the surface water supplies may only be used in designated places of use. The places of use identified in CWD's three water rights are described as follows:

- License 1387: "4,500 acres comprising the service area of Carmichael Irrigation District as shown on map filed with the State Water Rights Board on December 21, 1964."
- License 8731 and Permit 7356: "...a net area of 4,500 acres within an area of 4,950 acres comprising the service area of Carmichael Irrigation District as shown on map filed with State Water Resources Control Board on January 19, 1968."

²⁰ 23 CCR 660

²¹ 23 CCR 661

²² 23 CCR 663

CWD’s service area currently encompasses approximately 5,000 acres (which is closer to the designation in License 8731 and 7356).²³ Figure 7 depicts the various places of use as shown in documents on file with the State Board.

Figure 7: CWD Water Rights Place of Use Maps

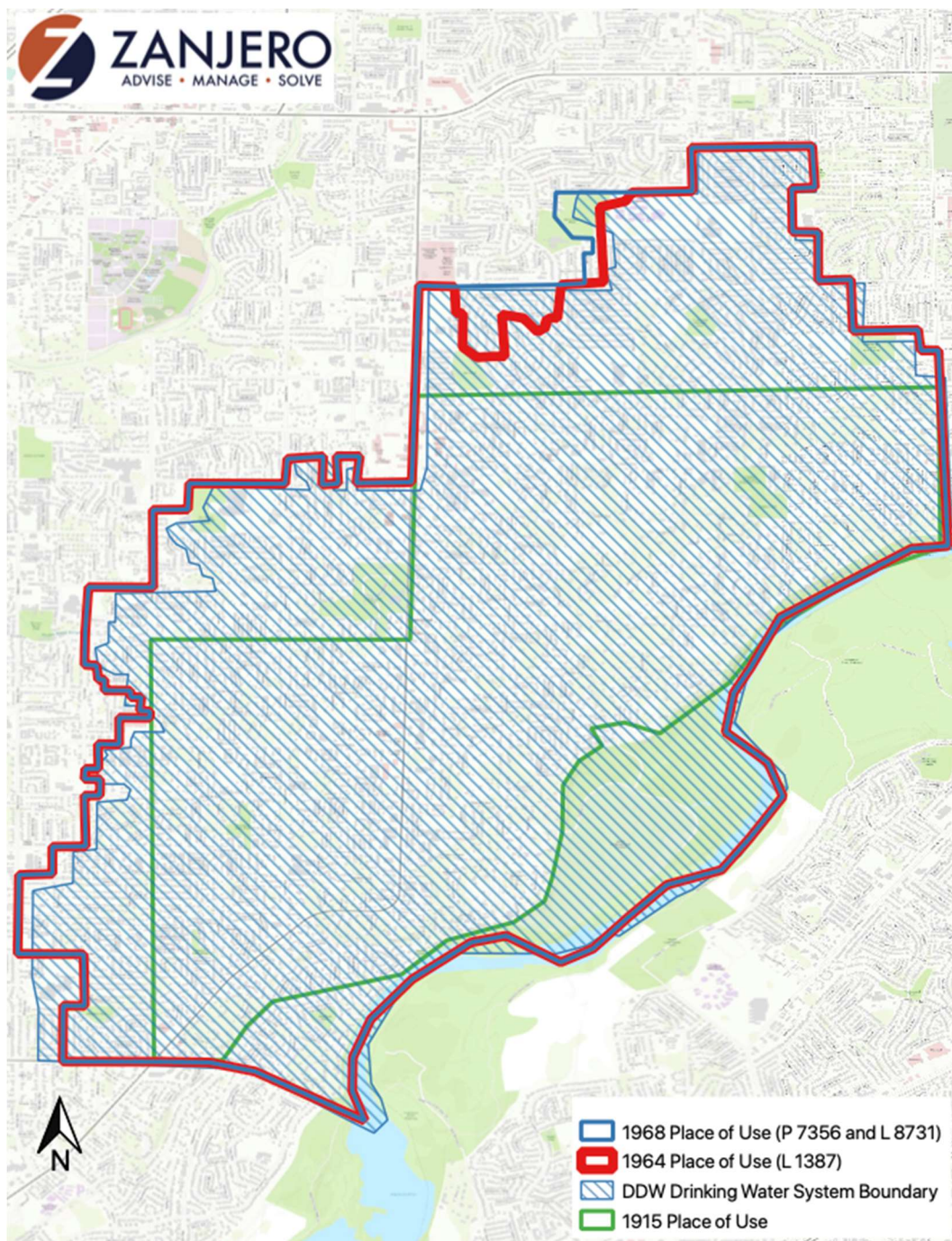

CWD’s Permit 7356 also has some unresolved issues that leaves the volume of water available to CWD under this supply in flux. In 2009, the State Board denied CWD’s request to renew Permit 7356, noting that CWD was not putting the water to beneficial use and that CWD did not adequately satisfy two of the three

²³ <https://carmichaelwd.org/about-us/district-history/>

necessary findings for a time extension. The State Board's Order stated "Permittee has not shown good cause for the time extension... Therefore, it is ordered that the State Water Board, hereby denies the petition for extension of time." The denied petition for extension for Permit 7356 renders the total water available under the Permit uncertain. Despite the 2009 Order, CWD continues to use and file reports demonstrating water use under Permit 7356, but the Order denying the Permit extension indicates that water under this Permit was not used at the time the Order was issued. As such, additional actions should be taken with the State Board to identify and secure available water supplies under Permit 7356 and to ensure that current diversions under Permit 7356 are legal.

4.1.1.1. Additional Surface Water Available to CWD

CWD contracted 300 ac-ft of San Juan Water District's pre-1914 appropriative water right to be used during curtailment only based on CWD's conservation efforts and other supplies. SJWD's pre-1914 appropriative water right from the American River has a priority date of 1853. This water right was perfected by the North Fork Ditch Company for diversion in all months of the year for domestic, irrigation, and municipal purposes. SJWD's pre-1914 appropriative water right has been delivered to areas in Sacramento County and Placer County and was further secured through a Settlement Contract executed with the United States Bureau of Reclamation for appropriations and construction of Folsom Dam and Reservoir. The total acreage encompassed within CWD for this water right is unclear but likely includes the Carmichael Colonies and areas encompassing CWD's boundary upon the District's formation in 1916. Accordingly, SJWD's pre-1914 appropriative water right may be used in CWD's service area within the right's place of use at any time as permitted by SJWD.

4.1.1.2. Aerojet Water

CWD also has access to remediated supplies from the Aerojet-Rocketdyne (Aerojet) Groundwater Extraction and Treatment (GET) program in the North Basin and South Basin. These water supplies are extracted and treated by Aerojet and then discharged into the American River. Aerojet's treatment facilities, called "GET LA" and "GET LB", are located within CWD's service area. GET LA is located at Ancil Hoffman Park and GET LB is located near CWD's Bajamont Water Treatment Plant (Bajamont). Historically, CWD had acquired water supplies from GET LA to serve a portion of the irrigation demands at Ancil Hoffman Golf Course. However, due to Aerojet ceasing GET LA operations, CWD is not able to utilize the water to meet the golf course demands without paying exorbitant operational costs to operate the GET LA facilities. CWD also has the capability to acquire water from GET LB and has exercised that option in curtailment conditions. Presently, Aerojet GET water may be captured from the GET facilities and directly used for non-potable uses or may be rediverted through a surface water facility after discharge to the American River. CWD's existing intake facilities have captured excess discharge from upstream Aerojet treatment facilities and CWD continued to work with Aerojet to pursue a long term contract similar to other GET water diverters like Sacramento County Water Agency (SCWA) and Golden State Water Company (GSWC).²⁴

GET water may also be used for direct potable uses so long as additional permits are acquired from the State Board. CWD could obtain the water derived from GET LB and incorporate that supply into its Bajamont treatment system. Specifically, under Process Memo 97-005, CWD may use an "extremely impaired water source" for direct potable uses so long as the water asset is treated to specific levels per the State Water

²⁴ SCWA holds a settlement contract with Aerojet to capture over 8,000 acre-feet per year of discharged GET water into its surface water diversion facilities and GSWC holds a contract for 5,000 acre-feet with a provision for as much as 10,000 acre-feet more should GSWC's needs arise.

Resources Control Board’s requirements.²⁵ CWD notes that the Division of Drinking Water declined this approach due to available groundwater supplies.

4.1.1.3. GSWC Water Supplies

CWD has attempted, but was not successful, to access Golden State Water Company’s surface water through its intertie at Bajamont, even though it has never utilized any GSWC supply. Normally, CWD diverts and treats up to 5,000 acre-feet of GSWC’s GET supplies at this location per GSWC’s settlement contract with Aerojet.²⁶ As such, in its simplest form, GSWC could forgo its GET water deliveries and allow CWD to take delivery of these supplies. These supplies have no place of use restrictions and are not subject to the rules germane to surface water appropriations. If GSWC’s GET supplies were delivered to CWD, GSWC could use groundwater supplies with Aerojet’s approval and its other surface water supplies to meet GSWC demands. In addition, the intertie pipeline was designed to move water in both directions, so it is plausible, with an addition of a pump station, that GSWC could deliver other components of its water asset portfolio to CWD for use in its service area.

4.1.1.4. Area D

A portion of CWD lies within areas served by the City of Sacramento’s surface water assets known as “Area D”. Area D overlaps approximately 390 acres within CWD that roughly aligns with Walnut Avenue. Area D’s intersection with CWD’s service area is shown in .

Figure 8: Map Showing Area D in CWD’s Service Area²⁷

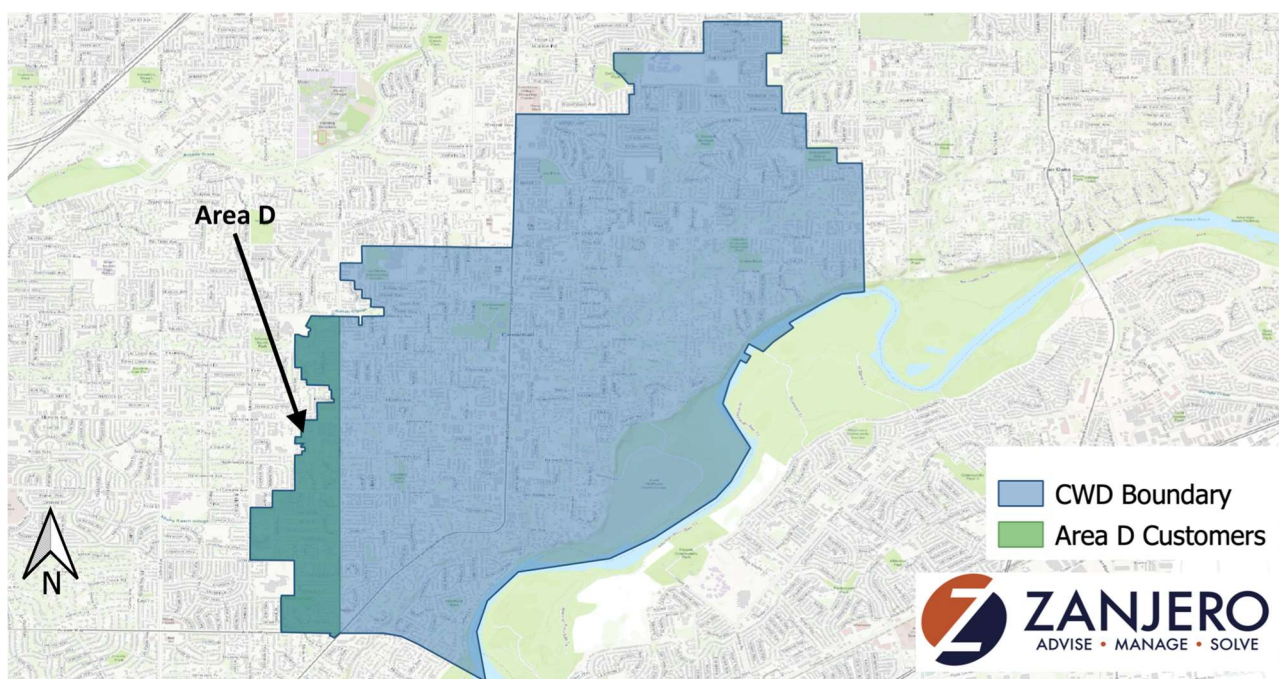

The City of Sacramento has several water assets that can be used within Area D totaling 26,064 acre-feet (AF). These water assets include the City’s surface water rights, including water rights linked to the

²⁵ https://www.waterboards.ca.gov/drinking_water/certlic/drinkingwater/docs/process_memo_97-005-r2020_v7.pdf

²⁶ Diversion, Treatment and Delivery Agreement By and Between Golden State Water Company and Carmichael Water District, August 24, 2016.

²⁷ Carmichael Water District 2020 Urban Water Management Plan at page 3-12.

Sacramento Municipal Utility District system operations in the upper American River watershed, and the City's water assets derived from the Sacramento River. Specifically, these assets include the City's water right permits 11358, 11359, 11360, and 11361 from the American River and Permit 992 and pre-1914 appropriation S025297 from the Sacramento River. The details of these assets are more fully developed in SSWD's portfolio section since SSWD is contracted to receive these supplies already. In short, this portion of the CWD may be capable of applying City of Sacramento's water supplies for beneficial uses in the portion of Area D inside CWD's service area boundaries. These supplies could be available to the District in Area D subject to CWD reaching an agreement with the City for sharing of those resources. CWD has begun an initial discussion with the City to deliver water into the portion of Area D that lies within CWD's service area boundary. The City has declined to file a temporary change in point of diversion for the City's water supplies but would coordinate wheeling activities with SSWD, as described more fully later in this section.

4.1.2. CWD Groundwater Supplies

CWD has five active wells with a total extraction capacity of 6,400 gallons per minute. CWD normally uses only four of these wells to serve customers. CWD also has additional decommissioned wells that could be available (after repair) to capture groundwater supplies within the groundwater basin.

4.1.3. SSWD's Surface Water Assets

SSWD possesses two long-term contracts for surface water supplies with the City of Sacramento and Placer County Water Agency and one short-term contract for surface water supplies with San Juan Water District. SSWD holds no surface water rights independent of these surface water contracts.

4.1.3.1. City of Sacramento Contract

SSWD entered into an agreement with the City of Sacramento in 2004 (2004 Agreement) to receive a maximum supply of 26,064 acre-feet per year. SSWD may obtain water supplies from the City pursuant to the terms of the 2004 Agreement under any of the City's water rights originating in the American River or Sacramento River. The ability to use supplies derived from these rights is subject to the rules in the 2004 Agreement related to "Firm" and "Non-Firm" capacity, the disposition of the rights subject to flow criteria (Hodge Flow) in the American River, and the obligations of the City to supply its customers with water supplies. The availability of the City's water supplies have been re-examined internally since SSWD developed its 2020 Urban Water Management Plan²⁸ and SSWD has additional opportunities to derive surface water supplies from both the American River and Sacramento River systems from the City's water asset portfolio that were not contemplated at that time.

The surface water supply contract with the City of Sacramento relies upon the six water rights (and the accompanying Reclamation contract) that are available to serve Area D. These rights include water right permits 11358, 11359, 11360, and 11361 from the American River and Permit 992 and a pre-1914 appropriation (S014834) from the Sacramento River. The details of these water rights are important for assessing the availability in SSWD's service area under the 2004 Agreement.

Two of the City's American River Permits – 11359 and 11360 – are derived from the Sacramento Municipal Utility District's (SMUD's) Upper American River Project (UARP) and are diverted and stored by SMUD as

²⁸ Sacramento Suburban Water District's 2020 Urban Water Management Plan indicates that the available supplies from the City include only those originating on the American River and that they are all subject to diversion restrictions under the Hodge decision (at 6-2).

part of its power generation activities. The release of this water from SMUD's UARP reservoirs is then available for re-diversion by the City of Sacramento for consumptive uses.²⁹ Thus, the City may appropriate water under these two rights based upon the natural flow on the American River and may also divert water based upon SMUD's storage and releases in the UARP. The City's "re-diversions" of water after they have been diverted to storage and released by SMUD are not subject to any restrictions related to the Hodge Decision or other flow requirements in the American River because they are managed releases derived from SMUD's hydroelectric power production in the UARP. These types of releases remove the flowing water from the natural flow characterizations that would otherwise apply to appropriative water rights. Accordingly, these water supplies are available for diversion all year so long as they can be derived from SMUD's UARP storage and release operations.

The water supplies available under Permits 11359 and 11360 may be used within the "City of Sacramento and adjacent areas, an area of 96,000 acres as shown on map."³⁰ The place of use has historically incorporated the entire place known as "Area D." Area D as it relates to SSWD and CWD is shown on the map in Error! Reference source not found..

²⁹ Decision 893 also applies to Reclamation's impoundment of UARP supplies that may be used to satisfy these rediversion water deliveries to the City.

³⁰ Note that the map referred to in this permit language is not shown in this report or that it refers to the map in the permit materials.

Figure 9: Map Showing Area D in Relation to SSWD's and CWD's Service Areas

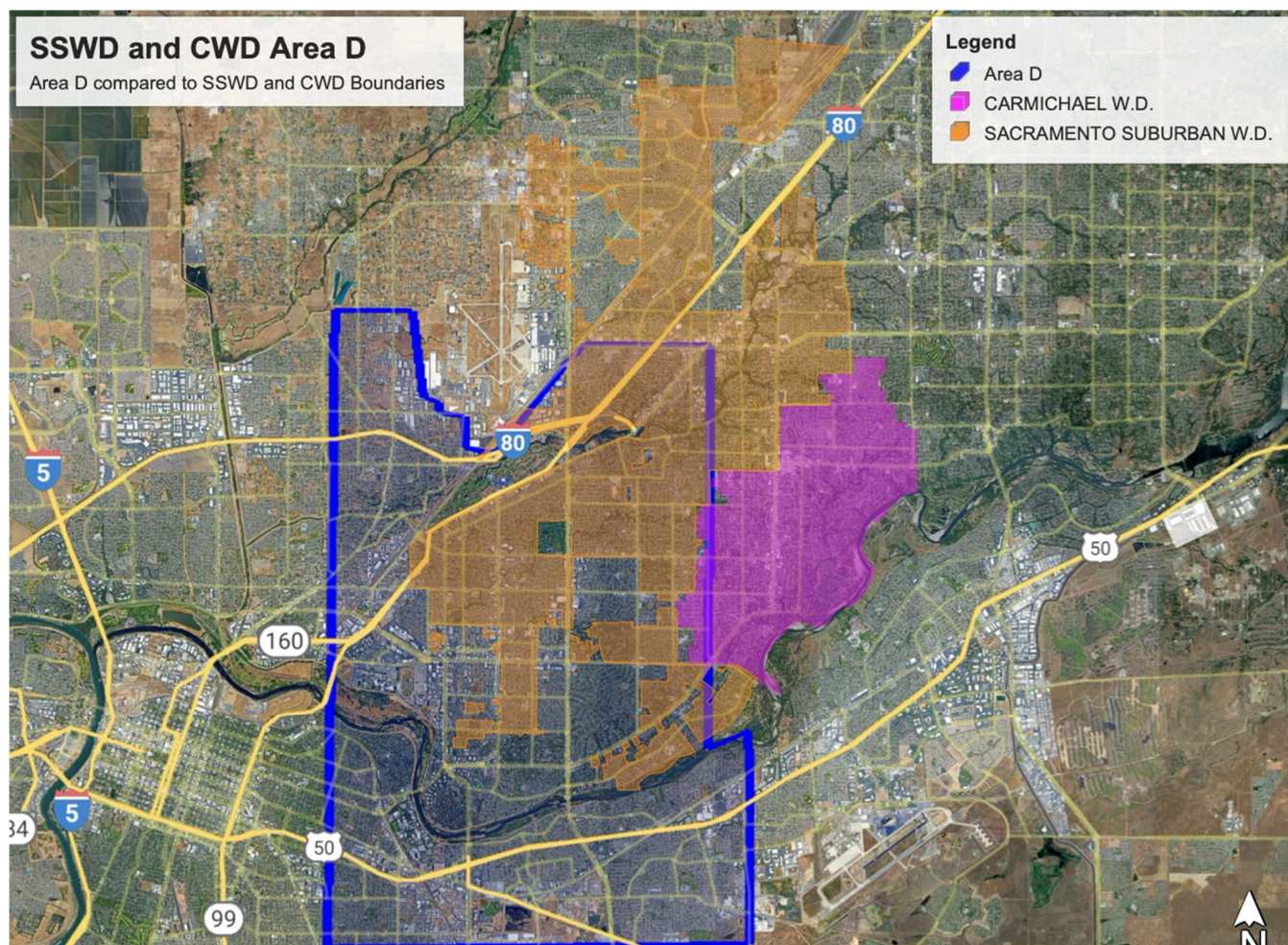

The City's other two American River Permits – 11358 and 11361 – are not connected to SMUD's UARP and, as such, may only be diverted when sufficient natural flow is available in the American River and the Hodge criteria are inapplicable. Specifically, the Hodge Decision prohibits diversion under these two permits when flows on the American River falls below 1,750 cubic feet per second (cfs) July 1 to October 15, 2,000 cfs October 15 to end of February, and 3,000 cfs from March 1 through June 30. Thus, these two water supplies may not be available for SSWD under the 2004 Agreement when natural flow conditions in the American River prohibit diversion.

The 2004 Agreement also anticipates the City delivering water to SSWD derived from its Sacramento River diversion facilities.³¹ All six City water rights may be diverted at the City's Sacramento River diversion facilities. The City's pre-1914 appropriation may be diverted and used in the "City of Sacramento" that is not detailed in the map accompanying in the Initial Statement of Diversion and Use filed in 1997. Moreover, there are discrepancies in the filed documents about the appropriation priority date that should be addressed to determine the precise long-term reliability of this supply.³² Nevertheless, despite the uncertainty in the place

³¹ SSWD purchased capacity in the City's Fairbairn Treatment Plant (\$45 million), which may be memorialized in the contract.

³² The Initial SODU indicates 1854 but other documents in the SWRCB records indicate 1849 and possibly earlier diversions.

of use, the pre-1914 disposition of this water supply could make it easier to use in additional areas within SSWD's service area.

The City's Permit 992 water right has a priority date of 1921 and allows diversions of up to 300 cubic feet per second for use in the City of Sacramento. Permit 992 has been issued numerous extensions for completion and amendments to allow diversion at the City's new diversion facilities. Accordingly, all six of the City's main water assets may be used for municipal and industrial purposes in SSWD's service area under the terms of the 2004 Agreement. Determining the exact places of use in SSWD's service area that could be available related to S014834 and Permit 992 is beyond the scope of this memorandum.

4.1.3.2. Northridge Park County Water District and City of Sacramento Contract

Northridge Park County Water District ("Northridge") entered into a water supply contract with the City of Sacramento in 1980. This water supply contract entitled Northridge to obtain 25 cfs, capped at 9,023 acre-feet, under City's four American River watershed water right permits (as noted in the previous section). The supplies under this contract could be used anywhere in that portion of Area D that lay within Northridge's service area. Northridge merged with Arcade Water District in 2002 and formed Sacramento Suburban Water District. As such, SSWD assumed the rights and obligations under the 1980 Agreement with the City and therefore may have access to use City's American River water supplies within all areas within Area D that currently lie within SSWD's service area, as shown in **Error! Reference source not found.** This opportunity may depend on whether or not the City rescinded the agreement upon non-payment by Northridge, which may be the case but has not been confirmed.

4.1.3.3. PCWA Contract

SSWD uses surface water purchased from Placer County water supplies that is derived from PCWA's water right permits 13856 and 13858. In 2000, these two permits were amended to include the place of use areas within Sacramento County that included portions of SSWD's service area. The exact place of use is recorded on a map dated July 31, 1996 that is on file with the State Water Resources Control Board (SWRCB).³³ This water is treated at SJWD's treatment plant before delivery to SSWD.³⁴ PCWA and SSWD extended the contract through 2045. SSWD is entitled to 29,000 acre-feet under the terms of the agreement, but the availability of that water supply is dependent upon the unimpaired inflow into Folsom reservoir and may be modified depending upon SSWD's previous year's payment and use. In short, this supply is generally only available in normal and above normal water years and the water supply available under the agreement may be subject to reduction for non-use if SSWD chooses not to receive it when it is available.

4.1.3.4. SJWD and SSWD Contract

SSWD entered into an annual water supply agreement with SJWD in 2020 for the purchase of up to 4,000 AF surplus water supply under SJWD's pre-1914 appropriative water right (S000656) from the American River. The agreement to supply this water ended on February 28, 2021 and must be renewed annually between SSWD and SJWD in order for SSWD to obtain water delivery. The water supply available under this contract was quantified as conserved water derived from SJWD's water conservation activities. This conserved water supply is generally available for SSWD's use in all year types so long as the needs of SJWD

³³ Order Approving the Change in Place of Use and Amending the Permit (for permits 13856 and 13858) dated May 24, 2000.

³⁴ Sacramento Suburban Water District's 2020 Urban Water Management Plan at 6-1.

and its retail agencies are fulfilled, and the temporary transfer agreement is renewed. SJWD provides this water through a temporary conserved water transfer and has identified existing environmental documents that cover the proposed deliveries. SSWD is not in the place of use of SJWD's pre-1914 appropriative water right, but is added to the place of use each year pursuant to the temporary transfer rules applicable to conserved water transfers and applicable environmental laws.

4.1.3.5. CVP Section 215 Water

SSWD has received a nominal amount of Central Valley Project (CVP) Section 215 water. This water is available for diversion when surplus conditions exist in the American River watershed as they relate to Reclamation's operations of Folsom Reservoir. When this surplus water is available, SSWD may have an opportunity to divert and deliver this water in its service area. SSWD's service area lies within the CVP's Place of Use.

4.1.4. SSWD Groundwater Supplies

SSWD has 74 wells with a total extraction capacity of 86,238 gallons per minute to capture groundwater supplies in the North Basin.

Note that several SSWD wells are offline due to mechanical issues. To address these wells and competition for support, SSWD signed a five-year contract with a well contractor in 2022, who will work 100% for SSWD, with an option to purchase the firm. This will assist in responding to both reactive and proactive issues to existing wells. In addition, SSWD is currently in the process of constructing six new wells, as well as six more wells in the next five to six years. The well contractor and expanding portfolio of groundwater assets would be a boon to a combined organization and help ensure the operability of the larger well portfolio.

4.2. Future Changes to Water Rights and Supplies

The water assets available to CWD and SSWD may be changed in the future. Climate variation and regulatory changes threaten the availability of each agencies' water supplies while opportunities with additional storage may prove advantageous to both Districts' conjunctive use activities. The brief sections below describe these key issues.

4.2.1. Bay-Delta Water Quality Control Plan

As noted in the 2021 Regional Collaboration Study³⁵, the Bay-Delta Water Quality Control Plan (Plan) may permanently change water rights in the Sacramento River watershed. In 2018, SWRCB adopted Plan amendments that require increased "unimpaired flows" in the tributaries of the San Joaquin River.³⁶ The implementation plan to meet the San Joaquin River's unimpaired flows requirements is informative for the Sacramento River watershed because the Sacramento River watershed plan is not yet fully developed.³⁷ Water diversions in the Sacramento River watershed will likely need to be reduced in order to meet the flow requirements necessary to meet the Delta Water Quality objectives. The American River watershed purveyors have been negotiating "Voluntary Agreements" that would provide the water supplies to meet the flow requirements into the Sacramento River from the American River. These negotiations have been slow and have encountered some opposition from external entities. Whether or not the Voluntary Agreement

³⁵ <https://www.sswd.org/about/sacramento-regional-water-utility-collaboration-study-reports>

³⁶ https://www.waterboards.ca.gov/waterrights/water_issues/programs/bay_delta/

³⁷ https://www.waterboards.ca.gov/waterrights/water_issues/programs/bay_delta/comp_review.html

negotiations are successful, the regional water purveyors will likely have some obligations to forgo diversions of some portion of their surface water supplies in certain time periods in order to meet the Plan objectives.

4.2.2. Snowpack and Runoff Variation

As noted in the Raftelis report in 2021, there are future climate change scenarios that also impact the timing, volume, and availability of surface water supplies.³⁸ The California Department of Water Resources (DWR) has already recorded decreases in snowpack and earlier spring runoff. DWR predicts that California will experience “a 48-65% loss [in snowpack] from the historical April 1 average.” This change in natural storage will impact the timing of natural flows in the American River watershed and thereby impact the availability of supplies under the water rights that have no storage components (all of CWD’s water rights and a few of the City of Sacramento’s water rights). In addition, California’s Natural Resources Agency recently published a report stating: “Our climate has changed. We are experiencing extreme, sustained drought conditions in California.... This is our new climate reality, and we must adapt.”³⁹

Accordingly, future considerations related to the viability of surface water supplies under changed climate conditions should account for potential changes to the availability of those rights based on snowpack and runoff variation.

4.2.3. Groundwater Banking and Extraction

The RWA is working to develop the Sacramento Regional Groundwater Bank (Bank) in the American River watershed region.⁴⁰ The Bank is a water storage facility with approximately 1.8 million acre-feet of storage capacity and an annual storage input of approximately 60,000 acre-feet.⁴¹ The proposed Bank could improve long-term regional water supply reliability by improving opportunities for conjunctive water management by regional purveyors. CWD and SSWD already conjunctively manage their available surface water and groundwater resources. The Bank would provide a more formalized opportunity for these entities to optimize their collective water assets for long-term water supply reliability and for water asset monetization. Utilizing the proposed Bank with an integrated conjunctive use program could maximize opportunities for both Districts.

4.3. The Opportunities

CWD and SSWD have numerous opportunities to integrate their water asset portfolios to meet both short-term and long-term water reliability objectives. This section will address the long-term water supply objectives that could be realized through a combination.

4.3.1. CWD’s Water Rights

CWD’s three appropriative water rights are not available for use in SSWD’s service area without obtaining authorization from the State Board. Specifically, CWD’s water rights have specific identified places of use that do not include any portion of the SSWD service area. In order to expand the place of use under CWD’s water rights, CWD would be required to file a petition for change with the State Board and the State Board

³⁸ <https://water.ca.gov/Programs/All-Programs/Climate-Change-Program/Climate-Change-and-Water>

³⁹ <https://resources.ca.gov/-/media/CNRA-Website/Files/Initiatives/Water-Resilience/CA-Water-Supply-Strategy.pdf>

⁴⁰ <https://rwah2o.org/sacramento-regional-water-bank/>

⁴¹ https://rwah2o.org/wp-content/uploads/2019/04/WaterBank_Insert_9-FINAL.pdf

would need to rule on the viability of the change petition. The State Board's determination would hinge on its findings, through an evidentiary hearing process, of whether the proposed change would cause injury to other legal users of water or the environment. Simply expanding the place of use of water available under the water rights would likely result in a determination that "more water would be used under the water rights than would have otherwise been used" and thus there would be a reduction in supplies available for other legal water users and the environment.

As an example, PCWA undertook this place of use expansion in order to include portions of SSWD's service area under their Permits 13856 and 13858. The State Board's petition and hearing process took over five years and was considerably expensive, approximating \$5 million in transaction costs. Nevertheless, PCWA was able to secure an expanded place of use to include SSWD's service area. This expanded use of water was not deemed injurious to other legal users because PCWA would only deliver supplies that it had already captured in its American River reservoirs. However, CWD does not have any reservoirs and only captures the natural flow of the American River. Thus, capturing additional natural flows that CWD otherwise does not already divert may be construed as injury to other legal users and the environment. Nevertheless, in a successful place of use change petition, both CWD and SSWD would be able to divert and treat water in wetter periods to optimize Bajamont Water Treatment Plant's spare capacity and store the water via ASR operations.

Additionally, a change petition that affirmatively demonstrated that CWD had historically been diverting and using the water may have a better chance of success. Specifically, CWD would need to demonstrate that affirmative actions within CWD have conserved water resources that CWD would have otherwise diverted and used but for those conservation activities. Conserved water is protected for future use under Water Code section 1011 and CWD has conserved as much as 4,000 acre-feet from its historical maximum use that could be made available for alternative uses. As such, there may be opportunity to expand the place of use related to CWD's conserved water for use in SSWD's service area through a State Board process, but the process would be prolonged and expensive.

CWD could also petition for a temporary change to potentially deliver conserved water or water derived from a groundwater substitution process into SSWD's service area. The State Board has never addressed a temporary change petition process that is derived strictly from conserved water that is no longer diverted by an agency. The State Board has heretofore only addressed conservation transfers that were attributable to reductions in consumptive use under the provisions in the Water Transfer Whitepaper.⁴² The American River watershed regional purveyors have been developing a program to facilitate urban conservation-based transfers. As noted in previous sections, SJWD has been successful in its conservation-based transfer with SSWD that is derived from its pre-1914 appropriative water right. CWD's water rights would require affirmative State Board approvals in order to execute a conservation-based transfer.

CWD could continue its foray into groundwater substitution transfers and deliver SSWD its surface water supplies under these temporary transfer rules. In this scenario, CWD would pump groundwater in an equal amount to the surface water it transferred to SSWD under any of its three water rights. Although this type of transfer is plausible, it would simply result in CWD increasing groundwater pumping and SSWD decreasing groundwater pumping and using CWD's surface water. In other words, a groundwater substitution transfer

⁴² https://water.ca.gov/-/media/DWR-Website/Web-Pages/Programs/State-Water-Project/Management/Water-Transfers/Files/Draft_WTWhitePaper_20191203.pdf

may not be a practical and cost-effective water management action between the two Districts as they would essentially be trading water supplies.

4.3.2. CWD's Other Supplies

CWD's other water supplies, not derived from CWD's groundwater wells, may be available for use in SSWD's service area. For instance, water supplies made available from GET LA and GET LB could potentially be diverted at the City of Sacramento's American River or Sacramento River diversion facilities and delivered to SSWD's service area. These developed water supplies derived from the treatment activities of Aerojet and discharged into the American River are available for diversion so long as Aerojet's other water supply contracts are satisfied.⁴³

The City of Sacramento's water supplies could be used in the portion of CWD contained in Area D, approximately 320 acres. Although the City of Sacramento has declined previously, the four Permit supplies derived from the American River watershed could be made available by adding a point of diversion to these rights to include CWD's Bajamont facilities and by coordinating an agreement with the City to divert, treat, and deliver those supplies to CWD's customers within Area D. It is probable that this process may be less scrutinized by the SWRCB because the water supplies were contemplated for use in Area D in previous water rights proceedings and the lands within CWD's service area are already part of the Permits. As such, there is no unanticipated additional uses associated with the change in point of diversion. In the alternative, SSWD could deliver these surface water supplies to CWD's service area in Area D through its existing 2004 Agreement with the City of Sacramento with an amendment recognizing the delivery to CWD's service area. This action is wholly within the current confines of the City's water rights and would not require any SWRCB approvals. Last, SSWD could deliver the City's Permit 992 and Pre-1914 appropriative water right into CWD's service area that lies within "the City of Sacramento" Area D boundaries. It may also be possible to deliver conserved water supplies derived from the City's pre-1914 appropriative water right (as SJWD does for SSWD) through SSWD's system. The City's availability to deliver Area D water is limited to the Hodge Decision and may not be available during the drier years. The engineering complexities of delivering water assets from the City's Sacramento diversion facilities to CWD's service area is beyond the scope of this memorandum. While the City has indicated that it will not open its permit to add new point of diversion, the State will automatically open the permit in 2030 or 2036, and at that point a temporary annual diversion could be explored.

As an alternative to a permanent change petition, the City could add a temporary additional point of diversion through the temporary change petition process that may make the City's four American River Permits easily available to CWD's service area in Area D on an annual basis with the SWRCB. Moreover, this action would allow CWD to divert and treat water that could then be delivered into SSWD's service area through the CWD and SSWD interties. This action may provide a litmus test as to the viability of adding a point of diversion for longer-term water diversions at CWD's Bajamont facility (or at least provide a precedent for future emergency transfers should they be necessary). The temporary change petition process is relatively straightforward, is exempt from the California Environmental Quality Act, and provides a streamlined approach to accomplishing the proposed objective. Accordingly, adding a temporary point of diversion for some of the City's American River water rights and diverting those waters at that location may provide a foundational piece for better water asset integration.

⁴³ SCWA and GSWC hold supply contracts for 8,900 AF and 5,000 AF respectively derived from Aerojet's GET water. The SCWA and GSWC contracts are settlement contracts from litigation related to groundwater contamination.

Last, SJWD's pre-1914 appropriative water right (S000656) is available for use in CWD's service area. This water right had historically been delivered to CWD and CWD has recently taken delivery of this supply for use in its service area by contract. The distinguishing characteristic of CWD's use of this supply is that the supply is not subject to any transfer provisions that are applicable to SSWD's use of the water. Specifically, whether or not the water had historically been conserved is irrelevant to the availability for use in CWD's service area. Accordingly, the SJWD water supply may be more valuable for use in CWD's service area than SSWD's service area, as it would allow for greater use under the water right that could support larger conservation-based transfers in the future.

CWD's groundwater supplies are derived from the same groundwater basin as SSWD's groundwater supplies. As such, there is no real limitation on the two agencies sharing supplies derived from their respective groundwater extraction systems.

4.3.3. SSWD's Water Contracts

The water supplies delivered to SSWD under the 2004 Agreement could not be used outside SSWD's service area without the concurrence of the City and a modification to the 2004 Agreement. Although the potential to deliver these supplies to CWD's service area exists, moving water from the City's Fairbairn Treatment Plant or its Sacramento River diversion facility up into CWD would require additional engineering analysis beyond the scope of this report.

SSWD's water contract with PCWA also has limited utility for CWD. PCWA's water right permits 13856 and 13858 do not include CWD in their places of use. As such, any delivery of these water supplies would require a temporary change petition at the State Board and a modification to the PCWA contract.

It is viable that CVP Section 215 water could be diverted at CWD's Bajamont facility and delivered to the combined entity. This action may require further consultation with the Bureau of Reclamation to determine whether an existing Warren Act Contract could cover these forms of diversion and use or whether an additional contract or an amendment would be needed to deliver these supplies. CVP 215 water is rarely available for delivery and under those conditions spare capacity at the Bajamont Water Treatment Plant may be sufficient to serve CWD's and SSWD's needs. The delivery of CVP 215 water into SSWD's service area through CWD's Bajamont system may be worth pursuing if SSWD's alternative surface water opportunities in wet conditions become problematic.

4.3.4. Conjunctive Management

CWD and SSWD have significant surface water and groundwater facilities available for conjunctive management actions. Developing options that allow additional surface water supplies to be directed through CWD's Bajamont facility for use in CWD's and SSWD's service area would be worthwhile to maximize groundwater storage and prepare for reduced reliability conditions. Finding opportunities to use more surface water supplies in both CWD and SSWD would allow both Districts to reduce their uses of groundwater and store that groundwater for alternative future uses. These in lieu recharge activities would further both Districts' groundwater management objectives.

In addition, actions that would allow CWD to inject its surface water supplies into a groundwater bank or for SSWD to inject the City's, PCWA's, or SJWD's supplies into a groundwater bank would also support the long-term conjunctive management objectives. Actions related to Aquifer Storage and Recovery (ASR) that

have been successfully developed in both the City of Roseville and the City of Woodland would be positive additions for a combined conjunctive management. Injecting and storing surface water in groundwater basins would require some additional modifications to CWD's, the City's, and PCWA's surface water rights. SJWD's pre-1914 water, Aerojet water, and other conserved water may not require any additional actions from the State Board in order to inject those supplies into the groundwater system.

4.4. Recommended Options for Water Asset Combination

CWD and SSWD may and have already been considering opportunities to combine water resources to best meet the short-term and long-term needs of their customers. The primary objectives of both Districts should be to maintain the same level of reliable water service in light of future climatological and regulatory conditions. The predicted conditions indicate that surface water supplies will be less available (in dry years, which are becoming more frequent, and summer months) based upon changed hydrological conditions in the American River Watershed and increased regulatory demand to meet the Bay-Delta Water Quality Control Plan requirements. Accordingly, developing opportunities to diversify the surface water asset portfolio and improve water storage opportunities would likely insulate CWD and SSWD against future surface water deficits.

CWD and SSWD have ample groundwater wells to extract native groundwater supplies and banked groundwater supplies to meet their combined needs. Although CWD may have less groundwater extraction wells, its connections to SSWD and their recent joint facility development efforts should alleviate any groundwater extraction restrictions. Maintaining and improving access to groundwater basins is a critical component of long-term water supply reliability for both Districts. However, it is equally important that CWD and SSWD capture and use as much surface water as possible in order to (a) improve banked groundwater supplies to meet long-term supply reliability; and (b) monetize surface supplies through future groundwater substitution water transfers.

CWD and SSWD should primarily focus the surface water combination actions on surface supply reliability under dry conditions in the American River watershed. There are four primary water assets that can improve surface water reliability:

- City of Sacramento's Permits 11359 and 11360 on the American River that are tied to storage in SMUD's Upper American River Project.
- SJWD's pre-1914 appropriative right that is available for use in a portion of CWD's service area and can be easily transferred to SSWD under conservation-based transfers.
- CWD's License 1387 use in SSWD's service area through a conservation-based temporary transfer through the State Board.
- GSWC's Aerojet Supply diversion and delivery in CWD's and SSWD's service areas.

4.4.1. City of Sacramento American River Water Rights

The City of Sacramento's Permits 11359 and 11360 have storage components that insulate them against drought conditions and are already available for use in CWD's service area that are contained in Area D. The storage components of these two rights allow them to be delivered for diversion to both SSWD and CWD even if natural flow conditions in the American River are low and if Hodge Conditions are met at the City's Fairbairn intake facility. An appropriate starting point for this diversion would be to coordinate with the City of Sacramento to temporarily add a point of diversion to include CWD's Bajamont Treatment facility for

delivery to CWD's portion of Area D. This initial step would set precedent for this type of action, especially under critically dry future conditions. Though, to date the City has been unwilling to add a permanent point of diversion when the permits are opened for review, a temporary annual petition might garner more traction.

4.4.2. SJWD Pre-1914 Appropriative Right Deliveries

SSWD and CWD have taken delivery of SJWD's pre-1914 appropriative water right (S000656). CWD took delivery because of its inclusion in SJWD's place of use and SSWD took delivery through a conservation-based transfer. Both entities may use this source of water and finding an opportunity to deliver the supplies in dry years – either through Bajamont or the Cooperative Transmission Pipeline (CTP) – would add redundancy to both Districts' supply portfolios. SJWD's supply is based upon its priority date and its contract with Reclamation, which includes storage and delivery from Folsom Reservoir. The right's priority date and storage component make it highly valuable in dry hydrological conditions.

4.4.3. CWD's License 1387 Conservation Transfer

CWD and SSWD should pursue a temporary conservation-based transfer of License 1387 through the State Board process to deliver water under License 1387 to SSWD. CWD and SSWD should target a normal water year to execute this transfer so as to lessen the perceived injury of this transfer to other legal water users and the environment. The conservation-based transfer would require quantifying that amount of water that CWD has conserved specifically under License 1387 (a portion of its 4,000 acre-feet of conserved water noted elsewhere in this memo) and delivering that water through its system intertie with SSWD into SSWD's service area. This precedent-setting transaction would provide a baseline from which to potentially include SSWD in CWD's water rights place of use for permanent conserved water deliveries.

4.4.4. GSWC Aerojet Supplies

GSWC's Aerojet water supplies are derived from Aerojet's GET facilities that discharge water into the American River watershed. These facilities produce 5,000 acre-feet of water that CWD diverts and delivers to GSWC at Bajamont. CWD and SSWD could secure temporary delivery of these supplies in dry years from GSWC by enabling GSWC to meet its dry year demands with groundwater extractions in its service area. The GSWC Aerojet supplies can be delivered to any location in CWD's and SSWD's service area without any formal approvals from any regulatory body and are impervious to dry year extraction restrictions.

If all opportunities are pursued and successful costs for these efforts could be as high as \$5.25 million in total and annual increases in water sales would produce an additional \$8 million in combined revenue annually based on staff's rough estimates.

5. Finances

In this section we review each agencies' finances and explore the implications of a potential combination of the two Districts. In each section, we discuss the current situation for CWD, SSWD, and the projected result should the two be consolidated.

5.1. Bookkeeping

Each District currently operates as a single enterprise fund. An enterprise fund is defined by the Governmental Finance Officers Association (GFOA) and the Governmental Accounting Standard Board (GASB), who set the guidelines for governmental accounting standards, as a separate accounting and financial reporting mechanism for municipal services for which a fee is charged in exchange for goods or services (akin to a business). Because utilities charge rates to ratepayers for their services, utilities operate as enterprise funds.

Consolidating the CWD and SSWD financials would necessitate a single enterprise fund for water operations. In essence, the current accounting structures could continue as-is, but would be brought together in a single set of books with a combined enterprise fund rather than one for each entity. All recovered revenue would be applied to cover the costs of water service provision and the combined District would continue to comply with all accounting standards and California laws. As is the case now, municipal governments cannot not funnel water revenues away from the agency except where they provide any specific services to the District, and no property tax revenues would be routed to the agency.

The most difficult aspect of combining finances would be merging into a single chart of accounts to govern coding of financial transactions. The consolidated utility would require one enterprise fund, and a full chart of accounts with codes for all necessary transactions would be required. At first, the two charts of accounts could be merged, and duplicative entries removed. The financial staff in the two utilities would need to meet and agree upon a new chart of accounts for implementation over time and make the associated changes to the setup in their respective financial software systems. Ideally, the chart of accounts would be fully merged and streamlined. The effort to create a unified chart of accounts and implement it into the systems is estimated to take six to twelve months.

Financial staff would also need to examine and determine which software systems, account codes, and procedures are most beneficial for use in the combined utility, though one primary software system, Microsoft Dynamics GP, is already used by each. While in the short-term the likelihood is that both systems would be run concurrently, in the longer-term a determination would need to be made about which setup and procedures best accomplishes the needs of the District. A review of the pros and cons of current and other potential systems and account structures would occur, a selection would be made, data transferred, and staff trained as needed. This could be a two-to-three-year process from start to finish, which is why having concurrent systems running in the meantime is likely necessary.

5.2. Revenues

Revenues for each agency are unlikely to be greatly affected by a combination and, in our view, would remain largely unchanged from current projections in the near to mid-term.

CWD has FY2022 budgeted revenues of just over \$17 million. Revenue sources are summarized as water sales (~90% of revenues), non-rate revenues (~9%), and interest income (~1%). Non-rate revenues include capacity sales, delivery charges, and connection fees. The following table shows a five-year breakdown of CWD revenues beginning FY18. CWD operates on a July 1st to June 30th fiscal year.

Table 3: CWD Revenues FY2018 to FY2022⁴⁴

CWD Revenues	FY2018 Actuals	FY2019 Actuals	FY2020 Actuals	FY2021 Actuals	FY2022 Budget	Percent Change FY2018 to FY2022
Water Sales	\$10,859,913	\$11,392,509	\$12,279,163	\$13,331,681	\$14,525,600	34%
Interest Income	\$47,719	\$138,012	\$155,748	\$48,458	\$23,000	-52%
Non-Rate Revenue	\$871,618	\$932,257	\$947,881	\$1,028,855	\$2,565,000	194%
TOTAL CWD REVENUES	\$11,779,250	\$12,462,778	\$13,382,792	\$14,408,994	\$17,136,600	45%

Reported rate revenue for CWD grew steadily by ~11% annually from FY2018 through FY2022, including projected FY2022 budgets. CWD received non-rate revenues from Aerojet through the Bajamont Water Treatment capacity sale to GSWC in 2016. During the study period of FY 2018 through FY2022, Aerojet's annual payment to CWD is \$1,400,000 per year. Beginning Calendar Year 2021, CWD also implemented a water rate increase of 9.5% per year with a majority portion of the rate increase revenue funding a reserve for the eventual replacement of Bajamont Water Treatment Plant's microfiltration system.

SSWD has FY2022 budgeted revenues of over \$51 million. Revenue sources were summarized as water sales (~93% of revenues), non-rate revenues (5%), and interest income (~2%). Non-rate revenues include facility development charges, delivery charges, and service fees. The following table shows a five-year breakdown of SSWD revenues since FY18. SSWD operates on a calendar year fiscal timeline.

Table 4: SSWD Revenues FY2018 to FY2022⁴⁵

SSWD Revenues	FY2018 Actuals	FY2019 Actuals	FY2020 Actuals	FY2021 Actuals	FY2022 Budget	Percent Change FY2018 to FY2022
Water Sales	\$44,092,000	\$43,902,000	\$47,643,000	\$48,559,000	\$49,957,000	13%
Interest Income	\$767,000	\$1,076,000	\$1,077,000	\$649,000	\$574,000	-25%
Non-Rate Revenue	\$3,932,000	\$3,171,000	\$2,430,000	\$2,731,000	\$830,000	-79%
TOTAL SSWD REVENUES	\$48,791,000	\$48,149,000	\$51,150,000	\$51,939,000	\$51,361,000	5%

FY2018 to FY2022 SSWD revenue generation was somewhat up and down depending on the year, in total growing by just 5% across the period. SSWD's revenue growth from FY2018-FY2022 lagged that of CWD's, though this is likely to the benefit of customers, as long as costs are recovered, and service levels are

⁴⁴ CWD CAFR 2021/CWD Budget 2022: pages 73/29

⁴⁵ SSWD 2021 Annual Report Page 78/2022 Annual Budget

maintained. This lower rate of growth reflects healthy support from reserves to minimize rate impacts. Higher rate increases for CWD have been recently required to ensure plant reserves are in place for the membrane replacement project, but over time may also be reflective of the smaller ratepayer base, which concentrates cost recovery among fewer customers.

Based on FY2022 budgeted revenues, the combined entity would have total revenues of approximately \$68.5 million. Table 5 summarizes the projected combined agency revenues. If combined, the resulting utility District would, at a surface level, have experienced 13% revenue growth from FY2018 to FY2022. However, this is not reflective of efficiencies that could be achieved through a combination, where it is expected that over time revenue trends would look more like that of SSWD than that of CWD.

Table 5: Combined CWD and SSWD Revenues FY2018 to FY2022

Total Revenues	FY2018 Actual	FY2019 Actual	FY2020 Actual	FY2021 Actual	FY2022 Budget	Percent Change FY2018 to FY2022
Water Sales	\$54,951,913	\$55,294,509	\$59,922,163	\$61,890,681	\$64,505,600	17%
Interest Income	\$814,719	\$1,214,012	\$1,232,748	\$697,458	\$597,000	-27%
Non-Rate Revenue	\$4,803,618	\$4,103,257	\$43,377,881	\$3,759,855	\$3,395,000	-29%
COMBINED REVENUES	\$60,570,250	\$60,611,778	\$64,532,792	\$66,347,994	\$68,497,600	13%

5.3. Operating Expenditures

Expenditures for each agency would initially be expected to remain near current forecasts if combined, depending on the desired pace of efforts to come together.

CWD had the following operating expenditures for FY2018 to FY2021 on an accrual basis as reported in available audited financial statements. Note the increase over time but also the fluctuations and variability by function. Such variability can be driven by high cash funding of capital, which both agencies practice, and the variability of capital needs. Cash balances and reserves can be used to smooth rate impacts during such periods of variability. It is also noteworthy that the ongoing but slowing Covid-19 pandemic occurred over this period, which had significant operational impacts on utilities and further drove trend breaks and variability in many communities.

Table 6: CWD Expenses FY2018 to FY2021⁴⁶

Category	FY2018 Actual	FY2019 Actual	FY2020 Actual	FY2021 Actual	Percent Change FY2018 to FY2022
Total Administrative Costs	\$3,185,882	\$3,057,560	\$3,543,045	\$3,685,101	16%
Total Production Costs	\$2,306,629	\$2,239,287	\$2,825,493	\$2,490,090	8%
Total Distribution Costs	\$3,987,102	\$4,149,381	\$4,405,074	\$3,789,747	-5%
Cash Funded Capital	\$1,891,322	\$2,307,762	\$6,123,364	\$4,154,579	120%
Total Debt Service	\$2,183,575	\$2,186,350	\$2,311,530	\$2,539,828	16%
Total Revenue Requirement	\$13,554,510	\$13,940,340	\$19,208,506	\$16,659,345	23%

⁴⁶ CWD 2021 Annual Report Page 73, Accrual Basis

SSWD had the following operating expenditures for FY2018 to FY2021 on an accrual basis as reported in available audited financial statements. SSWD has experienced declines in expenditures over this period as well as variability driven by cash funding of capital and the pandemic.

Table 7: SSWD Expenses FY2018 to FY2021⁴⁷

Category	FY2018 Actual	FY2019 Actual	FY2020 Actual	FY2021 Actual	Percent Change FY2018 to FY2022
Total Administrative Costs	\$9,533,000	\$9,983,000	\$10,374,000	\$9,981,000	5%
Total Production Costs	\$8,735,000	\$8,720,000	\$7,165,000	\$7,006,000	-20%
Total Distribution Costs	\$4,193,000	\$6,721,000	\$4,548,000	\$5,100,000	22%
Cash Funded Capital	\$17,800,000	\$17,200,000	\$15,600,000	\$15,400,000	-13%
Total Debt Service	\$7,462,000	\$7,150,000	\$7,238,000	\$7,121,000	-5%
Total Revenue Requirement	\$47,723,000	\$49,774,000	\$44,925,000	\$44,608,000	-7%

Most expenditures for both utilities are for essentials such as salaries and benefits, purchases of supplies and materials such as chemicals, and utilities. We assume for the purpose of this review that capital project expenditures going forward will also remain similar to those already in their respective capital improvement plans.

Variable expenditures include administrative costs like office supplies, some staffing, and other areas where a combined utility will result in overlaps of existing resources. In the short-term (2-5 years), there will likely be an increase in expenditures as the combined utility implements unified financial software and other support systems, contracts for various studies such as account classification and compensation reviews, and other costs of combination. Over time, it is expected that these costs of combination will cede as the newly combined entity moves forward and begins to benefit from efficiencies. Table 8 shows combined historical expenses from FY2018 to FY2021 as nearly flat over time as one agency increased spending and the other reduced spending, ultimately cancelling each other out. It is important to note that the rate impacts for customers would not have reflected these trends given the reserves and cash balances that were deployed in each year. Over longer periods of time, inflation will drive any organization's costs higher as operational costs like salaries and capital investment costs escalate, which is why often even organizations with available cash and reserves to buffer rate impacts tend to gradually escalate rates at least in line with inflation.

Table 8: Combined Expenses FY2018 to FY2021

Category	FY2018 Actual	FY2019 Actual	FY2020 Actual	FY2021 Actual	Percent Change FY2018 to FY2022
Total Administrative Costs	\$12,718,882	\$13,040,560	\$13,917,045	\$13,666,101	7%
Total Production Costs	\$11,041,629	\$10,959,287	\$9,990,493	\$9,496,090	-14%
Total Distribution Costs	\$8,180,102	\$10,870,381	\$8,953,074	\$8,889,747	9%
Cash Funded Capital	\$19,691,322	\$19,507,762	\$21,723,364	\$19,554,579	-1%
Total Debt Service	\$9,645,575	\$9,336,350	\$9,549,530	\$9,660,828	0%
Total Revenue Requirement	\$61,277,510	\$63,714,340	\$64,133,506	\$61,267,345	-0%

⁴⁷ SSWD 2021 Annual Report Page 78

5.4. Normalized Expenditures

This section is an analysis of cost per function comparing the financials for CWD and SSWD from 2018-2021. Average total costs were compiled and compared with the following functions: per connection, millions/gallons of water production (MG), per MG w/o Aerojet, per mile of pipe, per population served, and per acre. The following Figures 10 and 11 have been used to determine the efficiency of past costs per category.

Figure 10: 2018 to 2021 Normalized Costs per Connection

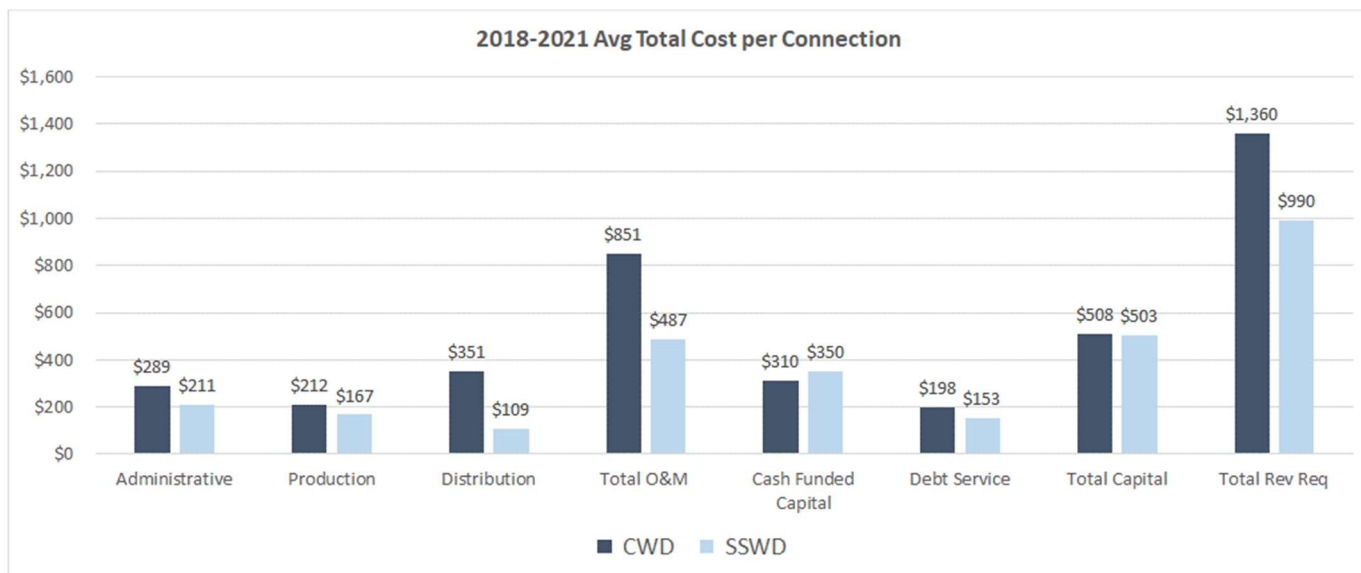

Figure 10 suggests that there is potential for scale efficiencies. There is a generally similar allocation of resources, for example SSWD’s total revenue requirement costs per connection are 73% of CWD’s (\$990 vs \$1,360).

Figure 11: 2018 to 2021 Normalized Cost per Million Gallons (MG) Produced

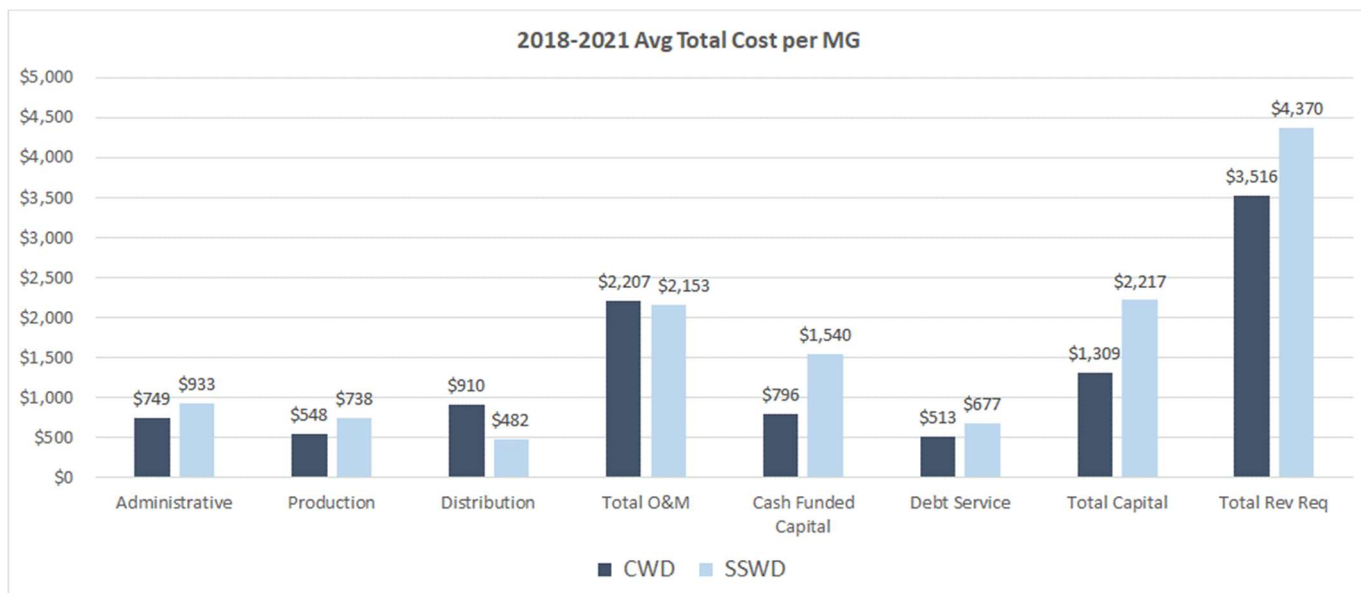

Figure 11 reveals that CWD’s revenue requirement costs per MG produced are 80% of SSWD’s (\$3,516 vs \$4,370). The significant difference in cost between these two utilities is driven by the GSWC/Aerojet contract which accounts for a single high volume CWD account.

Figure 12: 2018 to 2021 Normalized Cost per MG w/o GSWC + Aerojet

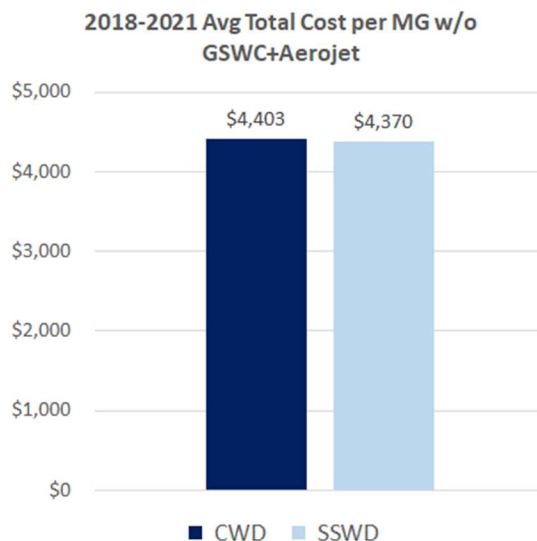

Figure 12 shows that SSWD’s revenue requirement costs on a per MG basis without Aerojet are similar to that of CWD, in fact, they are 99% of CWD’s (\$4,370 vs \$4,403). This is noteworthy because it highlights that costs per unit of production among retail customers (excluding the GSWC+Aerojet water) are similar. This is partly a result of higher consumption volumes per account across fewer accounts in the CWD service area relative to the SSWD service area.

However, other operational analytics outside of water production costs per unit, such as costs per connection, per mile of pipe, per acreage show greater differences. Those other metrics speak less to water production, and avoid the skew in the data produced by the higher consumption per account in CWD, and speak more to functions such as distribution, overhead, administration, customer service, conservation activities, finance, accounting, billing etc. It is in those other areas where relative efficiency appears to be concentrated at SSWD and can be realized through the combination. This is demonstrated in the other figures in this section where clear differences in costs are observed and tend to be lower at SSWD.

Figure 13: 2018 to 2021 Normalized Cost per Mile of Pipe

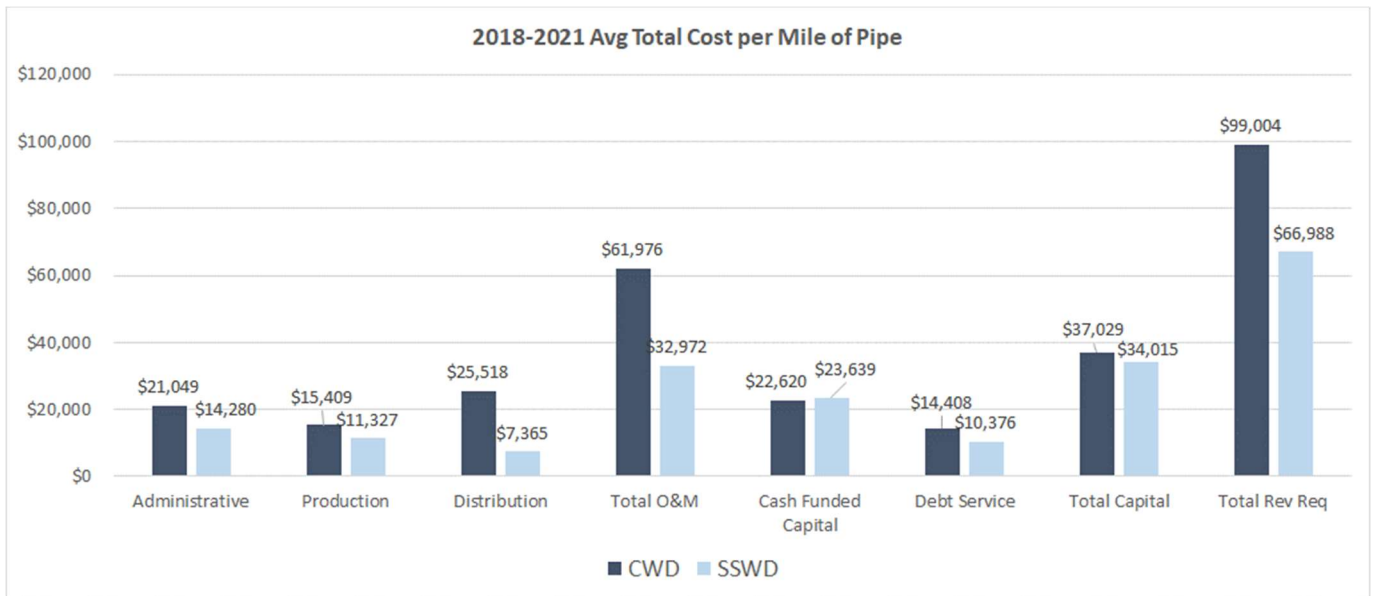

Figure 13 demonstrates that SSWD’s revenue requirement costs per mile of pipe are 68% of CWD’s (\$66,988 vs \$99,004). Most functions exhibit the same trend for this function, meaning that SSWD has greater efficiency. This data suggests that there is significant potential for combined efficiencies.

Figure 14: 2018 to 2021 Normalized Cost per Population Served

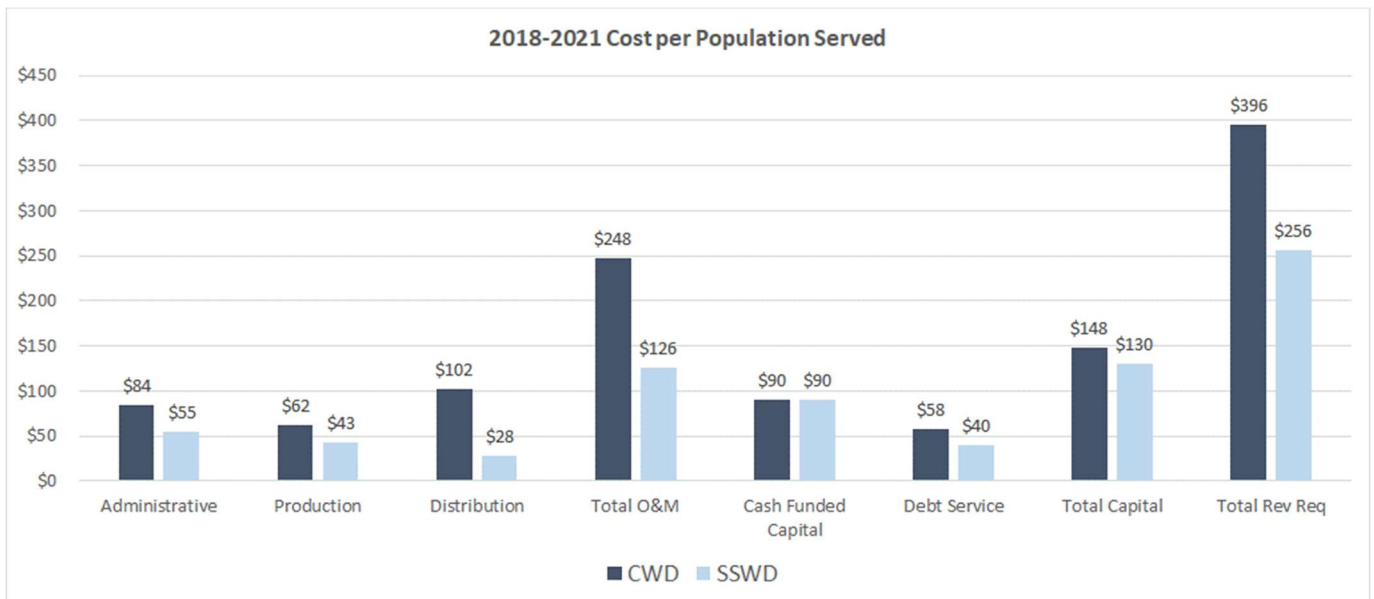

Figure 14 indicates that SSWD’s revenue requirement costs per population served is 65% of CWD’s (\$256 vs \$396). This data suggests that there is significant potential for combined efficiencies.

Figure 15: 2018 to 2021 Normalized Cost per Acre

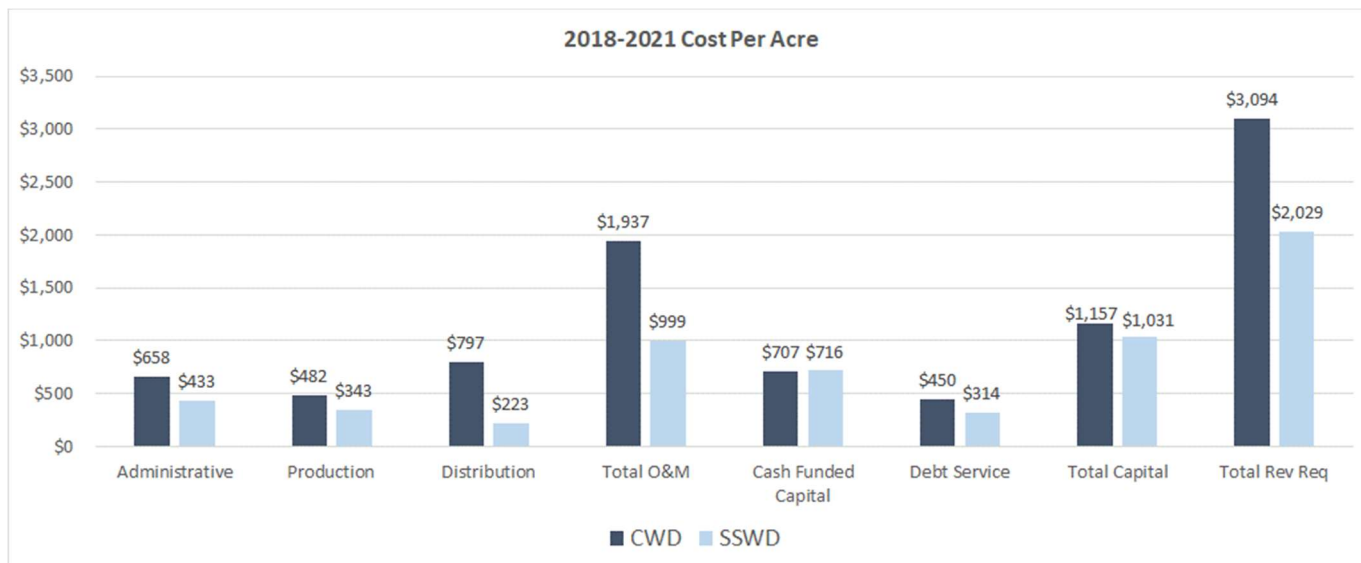

Figure 15 shows that SSWD’s revenue requirement costs per acre served is 66% of CWD’s (\$2,029 vs \$3,094). This data suggests that there is significant potential for combined efficiencies.

The normalized cost figures above display the differences in regional scale efficiencies between CWD and SSWD. In Figures 13, 14, and 15 CWD has consistently greater costs for the following categories administrative, production, distribution, total O&M, debt service, and revenue requirement. This frequent trend demonstrates SSWD greater financial economies of scale in all graphs except for Figure 11 (where CWD normalized costs are lower) and Figure 12 (where normalized true retail costs are about the same). The GSWC/Aerojet contract, which accounts for a single high volume CWD account, enables CWD to show greater overall scale efficiency in Figure 11, while the parity observed in Figure 12 is attributable to a high denominator of volumes due to do greater consumption per account behaviors. While the GSWC + Aerojet and consumption behavior dynamics may appear to muddy the waters of financial analytics as a combination is considered, broadly the hypothesized scale efficiency of larger organizations (in this case SSWD) is borne out by the breadth of financial analytics in the Report.

5.5. Capital Improvement Plans

The capital improvement plans (CIP) of CWD and SSWD lay out each utility’s investments in the water system typically over five- and ten-year forecasts. It is important to note the distinction between cash funded capital and debt service payments included in the operating expenditure review in Section 5.3 and the CIP, which includes all system investments in a given year including cash funding and cash flows from bond proceeds.

As for operating expenditures, CIP investments were normalized using a range of units to assess the intensity of investment levels at each utility. This analysis was conducted across historical data on actual investment levels as well as the available forecasts for each utility. While operating costs generally increase in a modestly upward fashion over time, CIP programs can be more variable and include spikes where major system components come due for replacement or there is significant growth and new facilities. For example, when the membranes at the CWD treatment plant are due for replacement, CIP levels are higher than in most other years. As a result of this variability, relatively higher normalized investment levels can be due to where a

given utility finds itself in time relative to its initial construction or other major infrastructure replacement milestones. Further, while higher normalized CIP investments can often drive rate impacts, this also depends heavily on how investments are ultimately financed and what available reserve levels are at the time of investment. Based on available data, a backward and forward looking capital investment trend covering the period from 2018 to 2031 is presented in Figure 16, we observe a steady upward trend in investment levels for SSWD and brief peak for CWD attributable to a period of more intensive investment in the system that includes the aforementioned membrane replacement project.

Figure 16: 2018 to 2031 CIP Spend

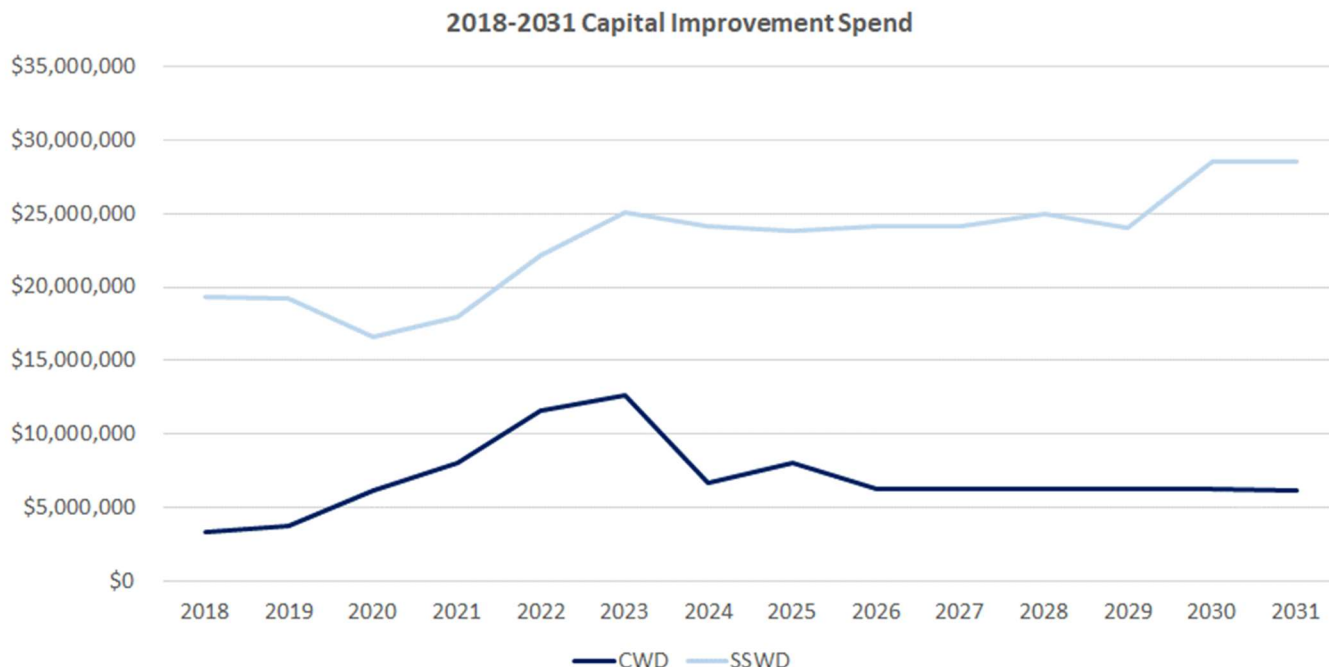

Figure 17 shows normalized (per connection) CIP cost comparisons to account for the different scales of the two utilities and to smooth investment over this same period (2018 to 2031) for comparative purposes. Generally, the observations from this data are consistent with the normalized operating expenditure analysis, as they again suggest that there is a degree of scale efficiency and savings in larger retail systems for most metrics (~20-30% range). However, again we see the impact of the award-winning GSWC and Aerojet agreement where we note that CWD on a normalized basis is able to produce water at a lower cost per MG (~32%). Further, again we observe that when we look at the retail water production of CWD, only a somewhat smaller advantage in CIP investment per MG produced is observed (~16%). Across the industry, groundwater is generally a cheaper source of supply than surface water; however, many individual retail accounts are also more expensive to serve than one large wholesale customer who consumes a significant percentage of a given utilities’ supply. In part the larger properties in CWD, which consume 56%⁴⁸ more water per account, also drive this normalized CIP per MG produced advantage.

⁴⁸ Based on California Water Board Reporting on residential gallons per capita per day (R-GPCD) for CWD and SSWD.

Figure 17: 2018 to 2031 CIP Per Connection

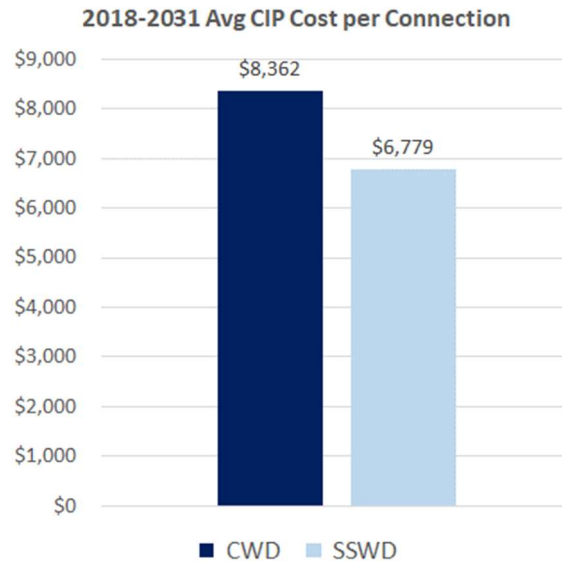

Figure 18: 2018 to 2031 CIP per Population Served

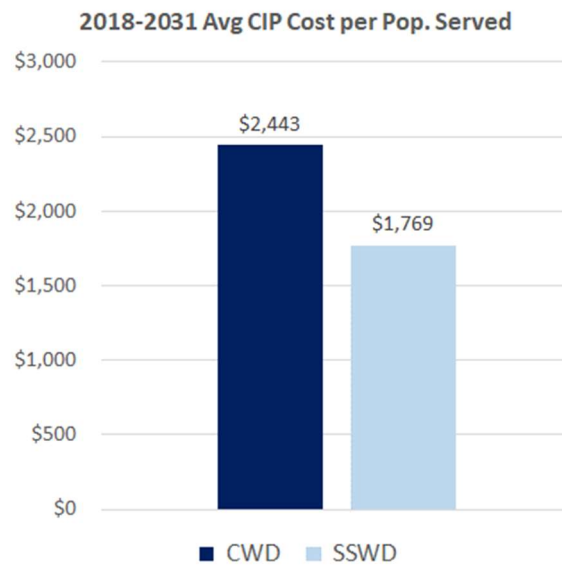

Figure 19: 2018 to 2031 CIP per Mile of Pipe

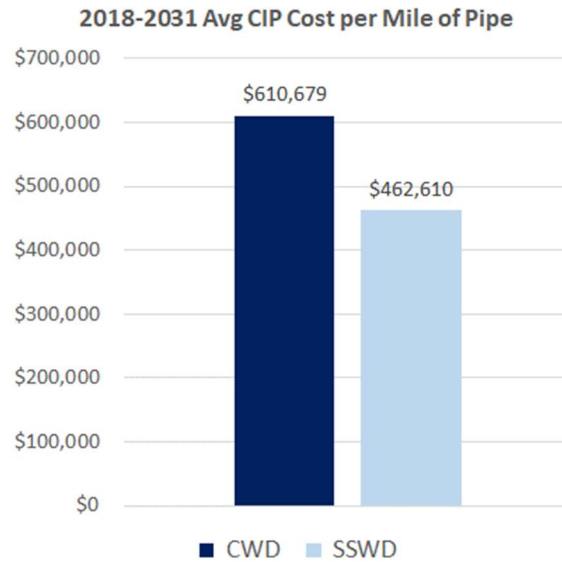

Figure 20: 2018 to 2031 CIP per Acre Area

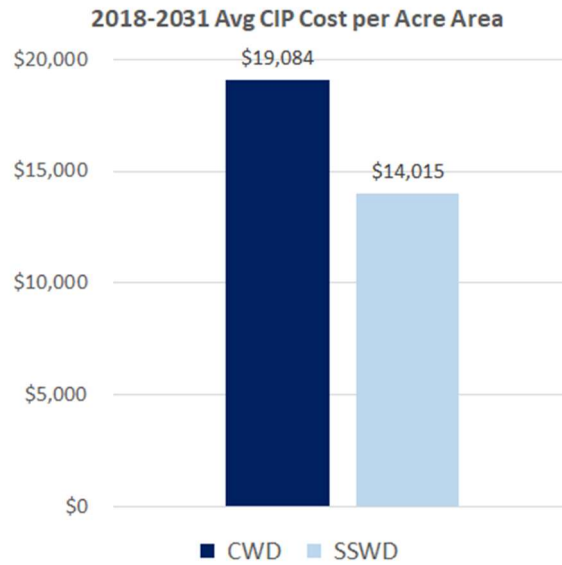

Figure 21: 2018 to 2031 CIP per MG Produced

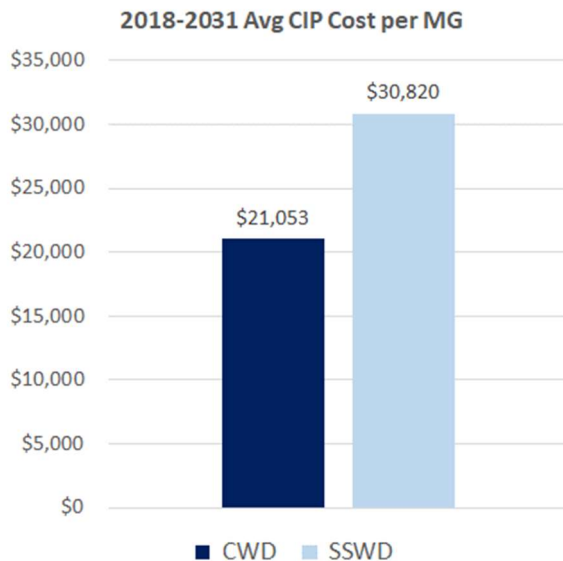
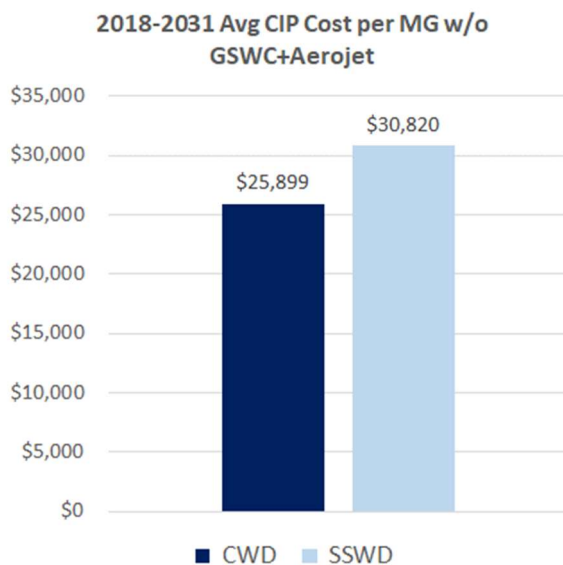

Figure 22: 2018 to 2031 CIP per MG Produced w/o GSWC + Aerojet



5.6. Debt Considerations

At the time of this review, CWD had two outstanding debts. The largest is the 2019 Certificates of Participation Series A, followed by 2019 Certificates of Participation Series B. The 2019 Certificates of Participation Series A was issued in 2019 to finance the acquisition and construction of certain water storage, pumping, treatment, transmission, and appurtenant facilities for the water supply, treatment, and distribution system. The Series A debt has an original issue premium which is being amortized over the life of the certificate, and an interest rate ranging from 4-5% with maturity dates from November 2030 through November 2037. The Certificates of Participation Series B was issued to refund the 2010 Water Revenue Refunding Certificates of Participation, and to pay certain costs incurred in connection with the execution and delivery of the Series B Certificates. The Series B debt has interest rates ranging from 1.834-2.739% with

maturity dates from November 2020 through November 2029. Both Certificates of Participation are jointly secured on a parity basis by the pledge of the revenues of the CWD's water system and certain funds and accounts created under the installment sale agreement and will be paid from said revenues and said funds and accounts without preference or priority with respect to one another. The obligation of the CWD to make such installment payments is a special obligation of the CWD payable solely from net revenues of the CWD's water system and said funds and accounts. The Installment Sale Agreement will require the CWD to fix, prescribe and collect rates fees and charges and manage the operation of the water system for each fiscal year to yield net revenues during such fiscal year ended of at least 120% of the annual debt service in such fiscal year. In the tables below are the yearly debt service payments along with the remaining balance on each certificate and premium.

Table 9: CWD Debt Obligations⁴⁹

CWD Debt Balance	2018	2019	2020	2021
2010 Certificate of Participation	\$20,964,732	\$18,620,000	\$0	\$0
2019 Certificate of Participation Series A	\$0	\$0	\$16,510,000	\$16,510,000
2019 Certificate of Participation Series B	\$0	\$0	\$15,775,000	\$14,300,000
Unamortized Premium	\$0	\$951,557	\$3,566,080	\$3,362,304
Total Debt	\$20,964,732	\$19,517,557	\$35,851,080	\$34,172,304

Table 10: CWD Debt Service⁵⁰

CWD Debt Service	2018	2019	2020	2021
Debt Service	\$2,183,575	\$2,186,350	\$2,311,530	\$2,539,828
Total Debt Service	\$2,183,575	\$2,186,350	\$2,311,530	\$2,539,828

In general, SSWD funds new capital with mostly cash; many of the bonds SSWD takes on are to refund previous obligations. At the time of this review, SSWD had four active debts, Series 2009A, Series 2009B, Series 2012A, and Series 2018A. The Series 2009A was issued in June 2009 for \$42,000,000 to refund the balance on the current Series 2004. The maturity of the Series 2009A is November 1, 2034. On April 19, 2012, the District issued \$29,200,000 of Refunding Revenue Bonds Series 2012A (bonds) at a true interest cost of 3.66%, to current refund the Series 2008A-2 COP obligation with an outstanding balance of \$33,300,000. This serial bond's maturity extends to November 1, 2027, and is subject to optional and extraordinary redemption provisions, without premium. On May 2, 2018, the SSWD issued \$19,615,000 of Refunding Revenue Bonds Series 2018A (Series 2018A Bond) with an average coupon rate of 3.40%, to advance refund \$22,065,000 of outstanding Series 2009B COP Obligations with an average coupon rate of 5.27%. The net proceeds of \$19,403,895 (after payment of \$211,105 in underwriting fees and other cost of issuance expenses) plus an additional \$3,533,324 of Series 2009B restricted debt service reserve funds were used to purchase U.S. government securities. Those securities were deposited in an irrevocable trust with an escrow agent and the Series 2009B COP has been repaid in full.

⁴⁹ CWD CAFR FY 2020-2021: Page 80

⁵⁰ CWD CAFR FY 2020-2021: Page 81

Table 11: SSWD Debt Obligations⁵¹

SSWD Debt	2018	2019	2020	2021
Series 2009A	\$46,632,000	\$46,288,000	\$45,937,000	\$45,578,000
Series 2009B	\$0	\$0	\$0	\$0
Series 2012A	\$17,502,000	\$15,102,000	\$12,628,000	\$10,068,000
Series 2018A	\$0	\$14,830,000	\$12,275,000	\$9,630,000
Total Debt	\$81,429,000	\$76,220,000	\$70,840,000	\$65,276,000

Table 12: SSWD Debt Service⁵²

SSWD Debt Service	2018	2019	2020	2021
Debt Service	\$7,462,000	\$7,150,000	\$7,238,000	\$7,121,000
Total Debt Service	\$7,462,000	\$7,150,000	\$7,238,000	\$7,121,000

Not included above, but relevant to this review are new bonds taken on by SSWD in 2022. On March 16, 2022, SSWD issued \$6,585,000 of Refunding Revenue Bonds Series 2022B (Series 2022B Bonds) with an average coupon rate of 1.86% to advance refund \$6,265,000 of outstanding Series 2012A Revenue Refunding Bonds (2012A Bonds) with an average coupon rate of 4.67%. The net proceeds of \$6,532,398 (after payment of \$52,327 in underwriting fees and other cost of issuance expense) were used to purchase U.S. government securities. Those securities were deposited in an irrevocable trust with an escrow agent to be used to satisfy the outstanding 2012A Bonds.

A consolidated debt service for both CWD and SSWD is provided in the following Table 13. As can be seen, debt service totals just over \$9 million per year, with the total combined debt around \$100 million in FY 2021 as shown in Table 14.

Table 13: Combined Debt Service^{53, 54}

SSWD + CWD Debt Service	2018	2019	2020	2021
Combined Debt Service	\$9,645,575	\$9,336,350	\$9,549,530	\$9,660,828
Total Debt Service	\$9,645,575	\$9,336,350	\$9,549,530	\$9,660,828

⁵¹ 2021 SWD Annual Financial Report: Page: 77

⁵² 2021 SWD Annual Financial Report: Page 78

⁵³ CWD CAFR FY 2020-2021: Page 81

⁵⁴ 2021 SWD Annual Financial Report: Page 78

Table 14: Combined Debt Obligations^{55, 56}

CWD Debt	2018	2019	2020	2021
2010 Certificate of Participation	\$20,964,732	\$18,620,000	\$0	\$0
2019 Certificate of Participation Series A	\$0	\$0	\$16,510,000	\$16,510,000
2019 Certificate of Participation Series B	\$0	\$0	\$15,775,000	\$14,300,000
Unamortized Premium	\$0	\$951,557	\$3,566,080	\$3,362,304
Series 2009A	\$46,632,000	\$46,288,000	\$45,937,000	\$45,578,000
Series 2009B	\$0	\$0	\$0	\$0
Series 2012A	\$17,502,000	\$15,102,000	\$12,628,000	\$10,068,000
Series 2018A	\$0	\$14,830,000	\$12,275,000	\$9,630,000
Total Debt	\$85,098,732	\$95,791,557	\$106,691,080	\$99,448,304

Figure 23 compares the most recent (2020) Fitch Water & Sewer Medians for Total Outstanding Debt per Capita to CWD, SSWD, and a combined organization. Note that the higher ratio in CWD may reflect financing obligations for investments in assets serving non-retail (GSWC & Aerojet) customers. Debt per capita for SSWD and the combined organization are nearer to Fitch Medians for the Far West region. Additional debt benchmarking should be conducted in future phases to ensure differences in obligations can be compared and understood more comprehensively.

Figure 23: Total Outstanding Debt per Capita

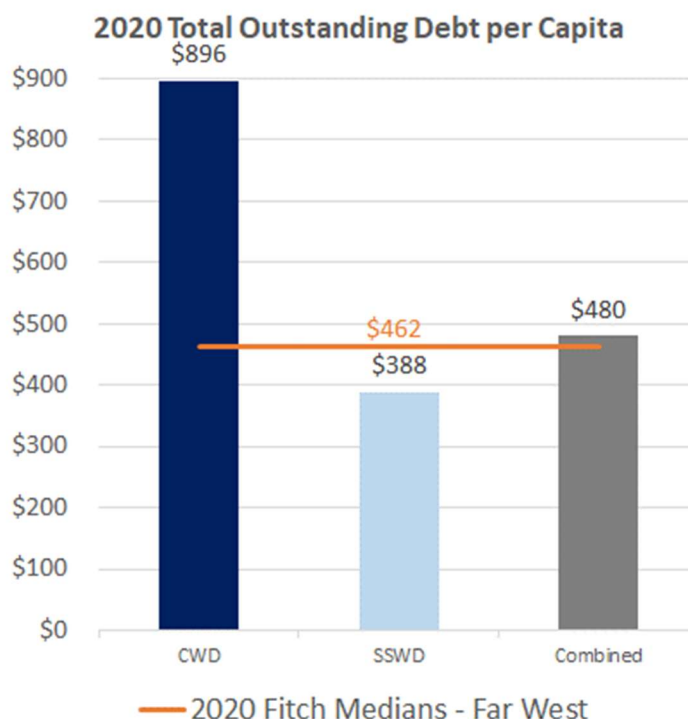

⁵⁵ CWD CAFR FY 2020-2021: Page 80

⁵⁶ 2021 SWD Annual Financial Report: Page: 77

5.6.1. Working Capital and Reserves

Working capital (reserves) for utilities are the accumulated difference over time between revenues and expenditures. When a utility's revenues exceed its expenditures, the difference is added to its working capital which will build over time with a goal of having funds available to help manage risk. Conversely, should a utility expend more than its revenues, this overspend in a single year will be drawn from the accumulations of working capital from prior positive years. Having funds available to mitigate risk is critical for utilities due to the uncertainty that can impact them, such as unforeseen breaks in very high-cost capital assets, lower than budgeted usage, extreme weather events, and source supply and energy costs that are not in the utility's control, among other factors. The level of working capital can be measured as the available buffer or margin for an enterprise fund.

According to its financial statements, CWD has established three different types of reserves: Unrestricted/Undesignated Cash, Designated Cash, and Restricted Cash, as summarized in Tables 17 through 19. Unrestricted/Undesignated Cash reserves are made up of the operating cash, and expenditures from this account are Board approved through the annual budget process. Designated Cash is kept to anticipate and prepare for significant financial obligations; this reserve is funded through the annual budget process and only may be withdrawn in the case of its specific purpose. Restricted Cash reserves are accounts held by the trustee or held by the District that are constrained through external requirements. Construction or acquisitions of capital assets and payments for long term debt are paid for from the restricted cash reserve.

Table 15: CWD FY2021 Unrestricted/Undesignated Reserves

Reserve Category	June 30, 2021 Balance
Operating Cash	\$11,239,033
Cash on Hand	\$1,000
Total	\$11,240,033

2020-2021 CWD CAFR pdf. Page 26

Table 16: CWD FY2021 Designated Reserves

Reserve Category	June 30, 2021 Balance
Membrane Replacement Fund	\$689,704
Operating Reserve Fund	\$3,568,489
Rate Stabilization Fund	\$500,000
Total	\$4,758,193

2020-2021 CWD CAFR pdf. Page 26

Table 17: CWD FY2021 Restricted Reserves

Reserve Category	June 30, 2021 Balance
Capital Assets	\$14,642,255
Debt Service	\$14
Facility Fees	\$599,331
Total	\$15,241,600

2020-2021 CWD CAFR pdf. Page 26

Per Table 18 SSWD, conversely, has no significant restricted or designated reserve funds at this time but does have two different cash reserves as shown in the following table.

Table 18: SSWD FY2021 Reserves

Reserve Category	Description	June 30, 2021 Balance
Restricted for Debt Service Reserve Fund	This component consists of external legal constraints placed on District assets by long-term debt holders.	\$16
Unrestricted Cash	This component of net position consists of the net amount of assets, deferred outflows of resources, liabilities and deferred inflows of resources that do not meet the definition of "net investment in capital assets" or "restricted for debt service reserve fund." Amounts included as unrestricted are available for designation for specific purposes as established by the District's Board of Directors. When an expense is incurred for which both restricted and unrestricted net position are available for use, it is the District's policy to use restricted resources first then unrestricted resources as they are needed.	\$35,873,664
Total		\$35,873,680

SSWD 2021 Annual Filing pdf. Pages 15,23

In summary, CWD reserve funds have been set aside from more specific uses by the organization, while SSWD reserves are also not available to be repurposed without Board action, but are committed to more general categories of use. In both cases, reserves can ultimately be changed by action of the respective Board.

5.7. Rates

Agency combinations can ultimately involve tradeoffs for customer bills should participating agencies seek to normalize rates over time with the goal of simplifying rate setting and financial management. The tradeoff may lead to rate increases for some or possibly even reduced rates for others, and as a result, how this transition is managed is critical to a successful combination. This section details the current rate structures and levels of each organization and discusses potential future states.

5.7.1. Sacramento Suburban Water District

SSWD rates include two customer account types. Both Non-Metered Flat Rate Accounts and Meter Rate Accounts pay user charges determined based on specified units, and fixed charge amounts that vary by either connection or meter sizes respectively. SSWD customers with Non-Metered Flat Rate Accounts must pay a usage charge at a predetermined dollar rate per thousand square feet of built area, as well as a fixed charge that varies by the size of their connection. Usage charges for Meter Rate Accounts are determined by two tiers of rates applied to different volumes of consumption (Single Family Residential) or by the customer class an account may fall in (Multi-Family Residential, or Non-Residential). Although usage is charged (\$/100 cubic feet) for all Meter Rate Accounts, different residential categories are charged at varying rates for their anticipated water usage to potentially incentivize water savings.⁵⁷

As mandated by California State law, all SSWD customers will be metered by 2025. Only a small portion of Non-Metered Flat Rate accounts remain, making this task achievable. Once the Water Meter Retrofit Plan has been fulfilled, the Flat Rate charge structure will become obsolete.⁵⁸

5.7.2. Carmichael Water District

All customers within the Carmichael Water District pay the same water usage rate in addition to their monthly flat service charge that is determined by the size of their water meter.⁵⁹ All CWD customers are metered.

5.7.3. Rate Structure and Bill Comparison

Typical Monthly Bills using the latest *Meter Rate Charge Structures* for CWD and SSWD (2022) are detailed in Table 19. Although the volumetric rate per CCF is higher for CWD, meter charges at CWD are consistently lower than SSWD. A range of decisions made in rate design studies and cost of service allocations can dictate these levels. Often utilities will allocate a portion of fixed costs (often 40% or less or capital costs) as well as meter service and billing charges into fixed charges, and the remaining portion of the revenue requirement from fixed and operational costs into volumetric rates.

⁵⁷ [Microsoft Word - SacSuburban Water COS Draft Report - 6-3-2018 \(sswd.org\)](#)

⁵⁸ [Water Meters | Sacramento Suburban Water District \(sswd.org\)](#)

⁵⁹ [2021-Water-Rates.pdf \(carmichaelwd.org\)](#)

Table 19: Summary of Current Rate Structures

Rate Component	CWD	SSWD
Volumetric rate per ccf:		
Tier 1 (0-15 ccf)	\$1.88	\$0.95
Tier 2 (16+ ccf)	\$1.88	\$1.24
Multifamily	N/A	\$1.35
Non-Residential	N/A	\$1.42
Meter Charge:		
Multifamily	\$32.01	N/A
5/8"	N/A	\$34.29
3/4"	\$32.01	\$47.56
1"	\$50.14	\$74.12
1.5"	\$94.46	\$140.51
2"	\$149.84	\$220.16
3"	\$276.73	\$432.60
4"	\$458.00	\$671.59
6"	\$911.18	\$1,335.44
8"	\$1,455.00	\$2,397.61
10"	N/A	\$3,194.24
12"	N/A	\$4,488.76

Figure 24 shows a typical bill using each agency's rates as applied to an annual average of the two service areas consumption (14.92 ccf per household per month) based on State reporting on the residential gallons of water consumption per capita per day (R-GPCD), an average household size of 2.6 people (US average), and a 3/4" meter size. Please note that CWD households more frequently have 1" meters, however this chart purposefully uses 3/4" meters to show an apples-to-apples bill comparison. The trend in Figure 24 (percent change over period CWD = +62%, SSWD = +27%) suggests that CWD will charge more than SSWD into the future if the trend continues, having recently eclipsed the typical SSWD monthly bill for the same meter size and water consumption. If we compared a 3/4" meter in SSWD to a 1" meter in CWD, that trend would likely be even more severe due to larger properties with larger meters using more water and with a higher unit rate for water would have higher bills. State reporting indicates that CWD accounts use 56% more water than SSWD accounts per capita on average.

Figure 24: 2017 to 2024 Bill Comparison for 3/4” Meters

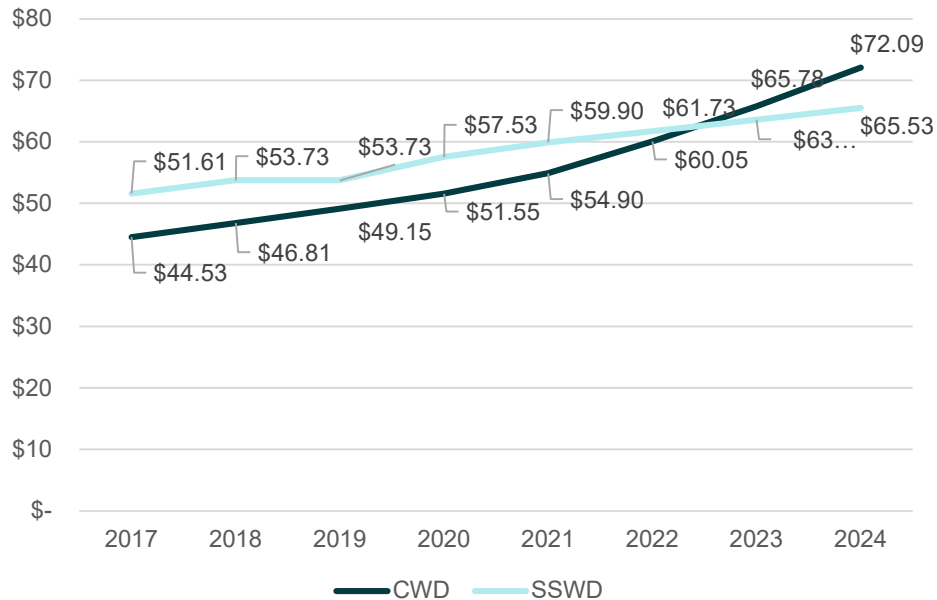
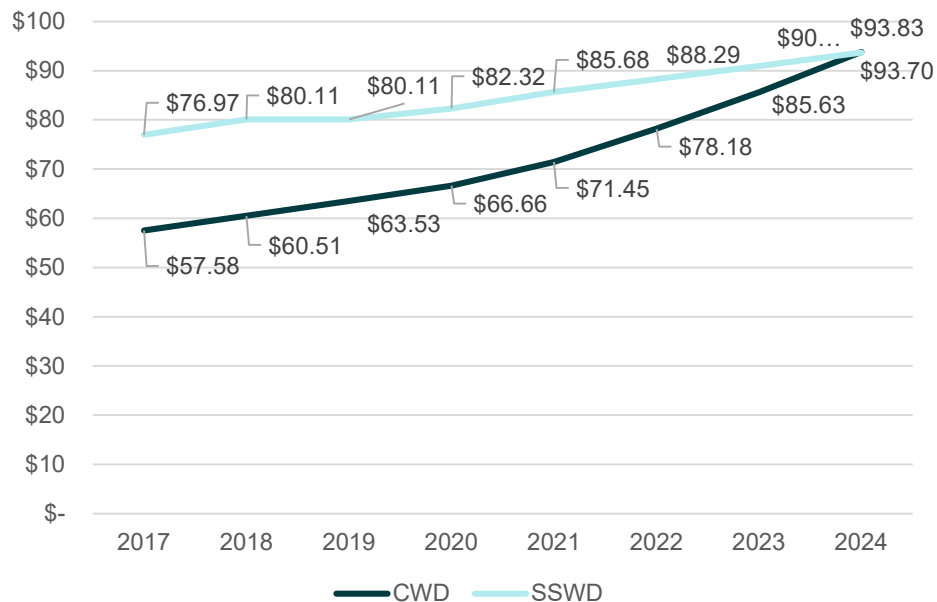

Figure 25 shows the same analysis for 1” meters. While historically the bills for 1” meters were more expensive in SSWD compared to CWD, as would be expected as the second and less common step in the meter charge scaling that would typically be done in rate design, the faster growth in CWD shows 1” meter bills eclipsing those in SSWD for the same unit of consumption. Had we used a higher consumption level (rather than combined average), the higher bills in CWD on this curve would likely occur earlier due to the higher volumetric rate in CWD at any SSWD tier.

Figure 25: 2017 to 2024 Bill Comparison for 1” Meters



Despite the observations being made about these curves, the key takeaway of this rate review is that CWD and SSWD actually have remarkably similar rate structures and bill levels. The impact of combination on

rates alone would be expected to have minimal impact on the bottom lines of a typical household's water billing in either District.

While the exercise of combining organizations will involve additional costs at first, it is expected that over time the rate of growth in rates would be less than otherwise expected given the scale efficiencies of a larger and more efficient combined organization. Since customers' bills are currently quite close, it is likely that the savings of combination would benefit customers and overcome any impact of rate alignment efforts to either party.

It is important to memorialize the concept of inflation, particularly in the water sector where costs are rising faster than in other parts of the economy due to climate change, drought, aging infrastructure, and supply chain issues. That is, where we use the term "savings" for customers, such savings would often be experienced as slower rate increases rather than rate reductions. This is because achieving the full benefits of combination will take several years to be realized depending on a number of factors such as required democratic processes, the level of aggressiveness of any Board and management cost cutting measures, water supply actions, system changes, and policy changes, all occurring as the rate of inflation of infrastructure proceeds along its current trend.

It is important for the Boards and management of each organization to focus not only on cost optimization for customers but also on service levels, water supply reliability, management simplicity, and the overall business case for combination rather than rates alone. In general, in this particular case rates do not appear to be a major factor in the business case in any way that would be obvious for customers, though over time benefits are expected due to greater scale efficiencies that are observable in normalized costs.

5.8. Financial Business Case Summary

In the prior regional study of collaboration opportunities in the Sacramento area conducted with CWD, SSWD and others, repeatable avoided cost ranges on the order of 8-20% relative to uncombined organizations were noted for utility consolidations. Such levels again appear achievable in this case based on the aforementioned 20-30% lesser costs at SSWD across normalized retail services. A key unknown variable is the monetization of water supplies, which could further drive economic benefits in this case.

A major unknown is the degree of potential surplus water supply monetization that could be achieved, as it is highly dependent on the degree of investments that the agencies make towards those efforts, market conditions, and regulatory actions outside of the control of the organizations. While based on current water rights and successful transfers there appear to be surpluses available, it is unclear to what degree exactly all of these opportunities can be subject to inter-basin transfers and how much might be curtailed by surface water and aquifer management decisions outside of the organization's control. Staff estimates up to an \$8 million increase in water sales or supply monetization over a 10 year period, relative to a maximum estimated expense for legal and other efforts contemplated to pursue all water supply opportunities of \$5.25 million. This results in a net profit for the water supply line item after 10 years of \$2.75 million that would grow over time, but is admittedly a very rough estimate.

Facilities costs are another variable that can impact the savings achieved and initial investment levels required. These costs could include a combined distribution facility and warehousing and would be subject to future Board and operational discretion as well as heavily dependent on market conditions. These are currently not believed to be immediately necessary. Further, any costs attributable to combining facilities

could ultimately be mitigated by the reductions in costs through combination realized over time as well as any equipment, land, or property proceedings from jettisoned facilities.

In addition to broadly expected savings due to scale efficiency and worker specialization, within 10 years of a combination several specific areas are worth highlighting as potential drivers of savings. Note that in some cases these potential savings may require up front expenditures to achieve them. Areas of expected savings over 10 years include, but are not limited to:

- Elimination of redundant staff salary and benefits (achieved through attrition or elimination of vacant budgeted positions as deemed appropriate by management)
- Providing benefits cost parity in line with current SSWD lower cost levels
- Consolidating existing legal services expenditures
- Consolidating the Board
- Collective monetization of water supply assets (in particular this effort could involve legal and other costs in the first 0-5 years of pursuit before yielding repeatable net benefits, which could be significant)

In addition, there are several areas where combination related activities may result in net costs. These include, but are not limited to:

- Providing salary parity, as SSWD salaries are higher
- Software & technology investments and studies required to align IT infrastructure
- Staff and facility relocation costs
- Additional combination-related studies or legal costs

Finally, it is important to remember that in addition to the financial upside potential of a combination of 8-20%, it is the increased ability to manage supplies, implement best practices, and provide quality and reliable service to customers that must also be qualitatively considered in any agency combination business case exercise.

Overall, the business case evaluation did not yield any fundamental barriers to combining agencies. Financial expectations are higher to the upside than to the downside, particularly over the longer-term. While there are initial net costs to combining, these would likely be outweighed by operational benefits and service reliability improvements, particularly once the combined agency refines its operational model and matures.

6. Communications

Please refer to Appendix F for the Communications Plan developed early in this Study. At the time of this writing, the agencies have already begun to follow the plan to ensure transparency about the process of evaluating the business case for a combination. Should the agencies move further down the path of exploring combination, this plan can be used as a guide to ensure engagement is purposeful and comprehensive. The plan should be updated periodically depending on the pace of any subsequent actions and evolutions in stakeholder dynamics and messaging needs.

7. Timelines & Implementation

If the business case is compelling for SSWD and CWD management and their Boards, it will then be important to move thoughtfully through an implementation timeline. If combination is pursued, it will likely proceed in three phases across near, intermediate, and long-term time frames. In the near-term over the next couple years, actions would need to be taken internally and then through the LAFCo and associated democratic processes. An intermediate transition period would then likely take three to five years before the combination reaches its full operating potential. Finally, within five years the combination of systems, staff, and operational optimizations should be in full swing.

7.1. Current State

If approved, by mid-2024 CWD and SSWD can likely move to combine through either of LAFCo's reorganization or consolidation procedures. The timeline below details key milestones along that path.

1. Conduct public outreach to educate CWD and SSWD stakeholders about reasons to consider combination (Sept-Dec 2022)
2. Boards review study and vote to move forward with combination next steps including any further studies required to confidently initiate LAFCo process (Oct-Dec 2022)
3. Prepare reorganization/consolidation application for LAFCo (Jan-March 2023)
4. Continue public outreach during LAFCo application process and respond to LAFCo comments and questions (March-Sept 2023)
5. Establish staff teams to work on key issue areas of HR, IT, facilities, operations, capital delivery, and finance (Sept 2023 to Feb 2024)
6. LAFCo process activities (Sept 2023 to Feb 2024)
7. Implement work team recommendations (Feb-June 2024)
8. Utilities formalize interim combined structure at start of new fiscal year on July 1, 2024
9. Begin interim phase

Throughout this suggested timeline the Board may direct staff to engage in further study of key areas of inquiry. These areas include those that emerged as this effort was reviewed by staff and the Board as well as desired next levels of detail for consideration as the potential combination is evaluated and further defined. Table 20 was developed based on feedback from staff and the Board and identifies many of these key areas as possible next steps:

Table 20: Possible Areas for Further Study

ITEMS	Phase/Activity 2	Phase/Activity 3
<u>Governance</u>		
Consolidation vs. Reorganization	x	
<u>Water Supply Assurances</u>		
CWD GW/Surface water rights	x	
SSWD GW/Surface water contract rights	x	
<u>Board</u>		
Transition in size	x	
Election district boundaries		x
<u>Administration</u>		
District Transition	x	x
General Manager		x
Legal Counsel		x
<u>Human Resources</u>		
Medical/Retirement Benefits	x	x
Salaries/Compensation	x	x
Staffing	x	
Organizational Chart		x
Office Locations		x
Fleet/Equipment	x	
<u>Financial</u>		
Timing of transition to one billing CI system	x	
Timing of transition to one financial system	x	
Rate Structures	x	x
Transfer of Assets	x	x
Capital Investments	x	x
Debt Service	x	x
<u>Operations</u>		
Integration of staffing	x	
Continuity of service	x	
DDW Permit Amendment		x
<u>Other</u>		
“No harm” to existing customers	x	
Lessons Learned – AWD/NWD	x	
<u>Cost Savings or Reduction in Increases</u>		
Reduction in future additional staffing	x	
Water Transfers	x	
Lost access to surface water	x	
<u>LAFCO Items</u>		
Infrastructure needs and deficiencies	x	

ITEMS	Phase/Activity 2	Phase/Activity 3
Growth and population projections for the affected areas		x
Financial constraints and opportunities	x	
Cost avoidance opportunities	x	x
Opportunities for rate restructuring	x	x
Opportunities for shared facilities	x	
Government structure options including advantages and disadvantages of consolidation or reorganization of service providers	x	
Evaluation of management efficiencies	x	
Local accountability and governance	x	
MSR/Sphere of Influence	x	x

7.2. Transition Period

If combination is approved, the full synergies of the larger entity will take time to realize. During a transition period estimated at three to five years, staffing and Boards can be optimized through role change or attrition at the discretion of the Boards and utility leadership and management. Current vacancies across the organization suggest that staffing impacts can be minimal. During this period, systems integration will also proceed with decisions about preferred financial, billing, CIS, CMMS, GIS, and other critical supporting software taking shape. Beyond the cost avoidance that is expected to result from scale efficiencies, role specialization, and systems integration, large financial decisions about water supply optimization and any facilities modifications can also be explored during this period. By the end of this period, staffing levels should take essentially their “final” form given that CWD and SSWD are largely built out communities where staffing is not expanding through growth.

The transition period will allow a newly created Strategic Advisor/Business Operations Executive role to manage the combination as gradually as desired to make it beneficial for staff rather than stressful. This is a period where each organization’s staff will find opportunities in each activity and function to make a larger impact in regional water management and service delivery for their communities, while also presenting opportunities for staff to specialize more fully in the tasks and functions that they most enjoy and excel at. If the combined staff is not engaged in a collective bargaining contract at the time of the combination, this is also a period for staff to gel and determine if that approach is desirable under the combined entity. The Strategic Advisor/Business Operations Executive role would go away once the transition is complete, with the Director of Finance and Administration role taking over leadership of that branch of the organizational chart at that time.

7.3. Future State

After the transition period, the goal is to have a combined organization that is firing on all cylinders with a lean but well supported staff of specialized experts and focused divisional and organizational leadership, management, and governance. It is during this period where the benefits of the combined organization will begin to significantly compound year over year as service levels are optimized based on the best practices and thinking from both current Districts. It is expected that annual cost avoidance of 8% to 20% will be realized relative to a current path where the organizations remain separate. Importantly, given the changing climate of California it is also expected that during this period the water supplies of these two areas will be more secure

than they could otherwise have been for its citizens given the combined capabilities and water rights of CWD and SSWD. An even longer-term goal might be to consider additional integration with surrounding utilities that do not benefit from the resources of an agency as capable and efficient as CWD and SSWD can become together.

8. Conclusion

There are both pros and cons to considering a combination of CWD and SSWD. This Report represents a preliminary assessment but did not identify any fatal flaws of a potential combination.

Prominent pros include the following:

- Ability to achieve greater scale efficiencies through a larger organization: the two entities each have areas of strength, as well as under and over-utilized staff; combining the two entities could provide efficiencies if resources are used strategically
- Greater water resource sharing and utilization: maximizing the use of water resources is a complex process filled with regulatory and political hurdles, but with the portfolio of groundwater, imported, remediated, and surface water assets possessed by both Districts, there are significant opportunities to maximize resources
- Greater political advocacy: a larger organization that covers a broader service area will likely be able to increase its political advocacy in the region, helping it protect resources and ensure that it is appropriately represented so customers' needs are addressed
- Higher levels of customer service are possible by combining resources, allowing more specialization of staff, greater levels of scale efficiency, and perhaps new or expanded services
- More rate and financial stability are possible with a combined organization featuring a larger and stable of water resources, a broader customer base, and an improved ability to deal with changes in operating conditions brought on by water resource challenges, staffing shortages, and inflation
- Upward mobility for staff at a bigger organization
- Transparent and well preceded process with LAFCo and SSWD history of success

While the pros to combination are significant, there are also notable cons including the following:

- A perceived loss of local control and the dilution of representation in a combined entity may be a concern; a combined entity would have Board members representing a larger number of constituents, assuming the Board is of the same size as the current Boards
- A larger organization often means more bureaucracy, and if not managed, redundancy and inefficiency; sound leadership will need to ensure scale efficiency is created while avoiding the pitfalls of a larger organization
- Adapting to changes can be challenging for staff, which requires attention and management effort to effectively navigate and thoughtfully consider as the new organization takes shape
- Challenges to water resources and/or limited ability to maximize resources: the regulatory and political environment may make it difficult to use water resources with maximum efficiency and could even invite some challenges to current arrangements

Industry data suggests savings in the range of 8-20% annually could be achieved once a combination reaches its full potential typically within 10 years of the planning stage of integration. This proceeds from broad worker productivity gains attributable to increased specialization, systems optimization, and the ability of the combined larger ratepayer base to bring down costs per unit and drive additional efficiencies. The variability in this figure may be driven by the scale of improvements in the use of water resources, which are possible, but may take time to realize.

Given that some of the pros and cons of combination are subjective, a decision to combine cannot be based solely on a quantitative cost-benefit analysis. However, Raftelis estimates that a combined entity could over time at least achieve the same level of cost per customer as SSWD currently achieves. This would provide value to current CWD customers and is highly likely to provide some savings to current SSWD customers. Nevertheless, the biggest potential benefits carry the biggest number of unknowns. Integrating water resources could buttress existing water supplies and has the possibility of substantial monetization, but there are regulatory and political challenges. Integrating the staff and operations of the two entities could provide a host of benefits, but if not managed well could result in new inefficiencies and a host of staffing problems. Fundamentally, this Study concludes that there are no fatal flaws to combining the districts. Still, the districts will need to work together to get to the end point of analyses and proceed to next steps with confidence. A more detailed assessment of the operational, funding, and financing considerations of a combination will be addressed in future phases of analysis. From there a careful and deliberate process is recommended for integration.

This page intentionally left blank to facilitate two-sided printing.

APPENDIX:

Appendix A: CWD Organizational Chart



This page intentionally left blank to facilitate two-sided printing.

CWD Organizational Chart

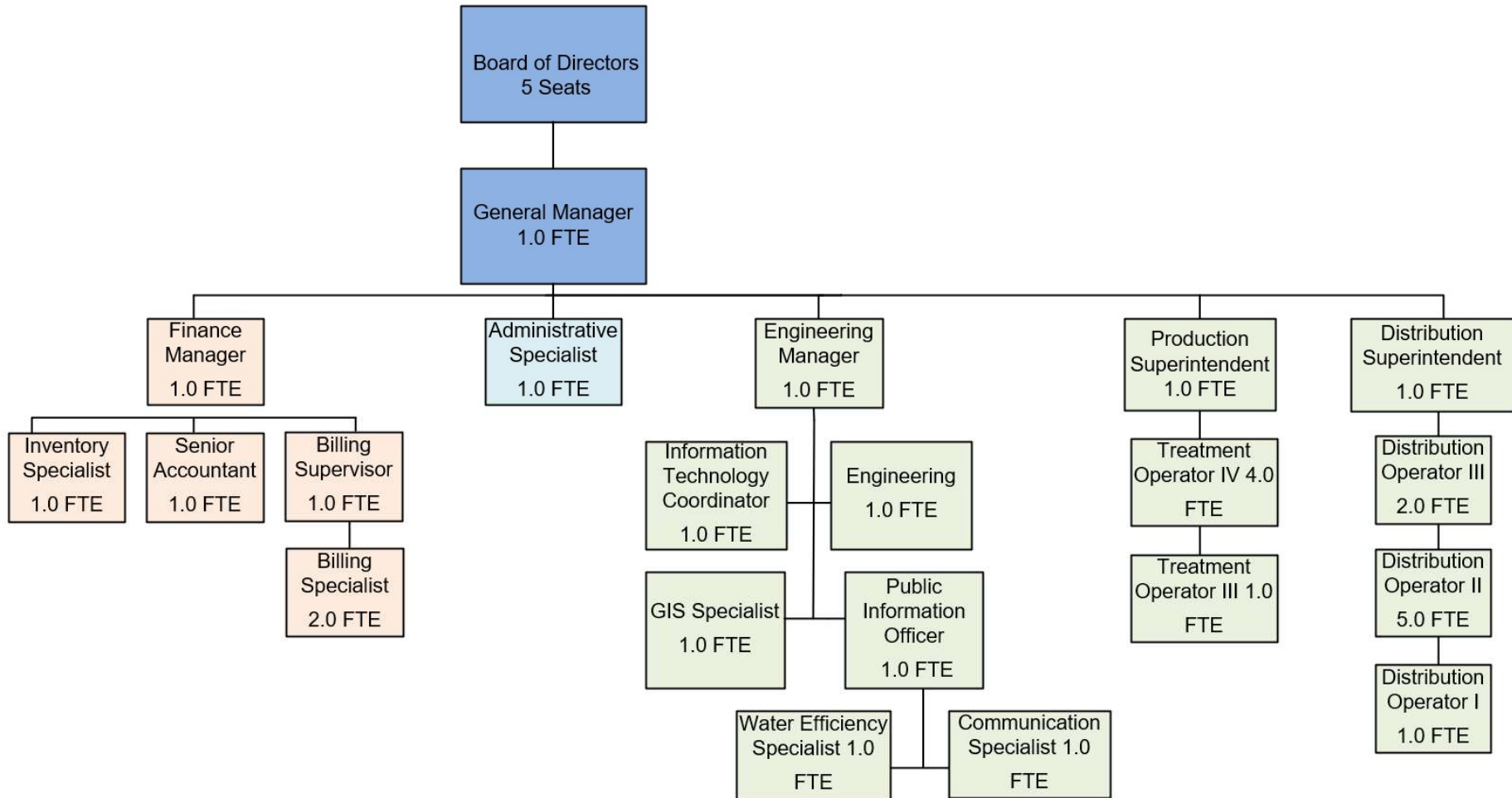

This page intentionally left blank to facilitate two-sided printing.

APPENDIX:

Appendix B: SSWD Organizational Chart



This page intentionally left blank to facilitate two-sided printing.

SSWD Organizational Chart

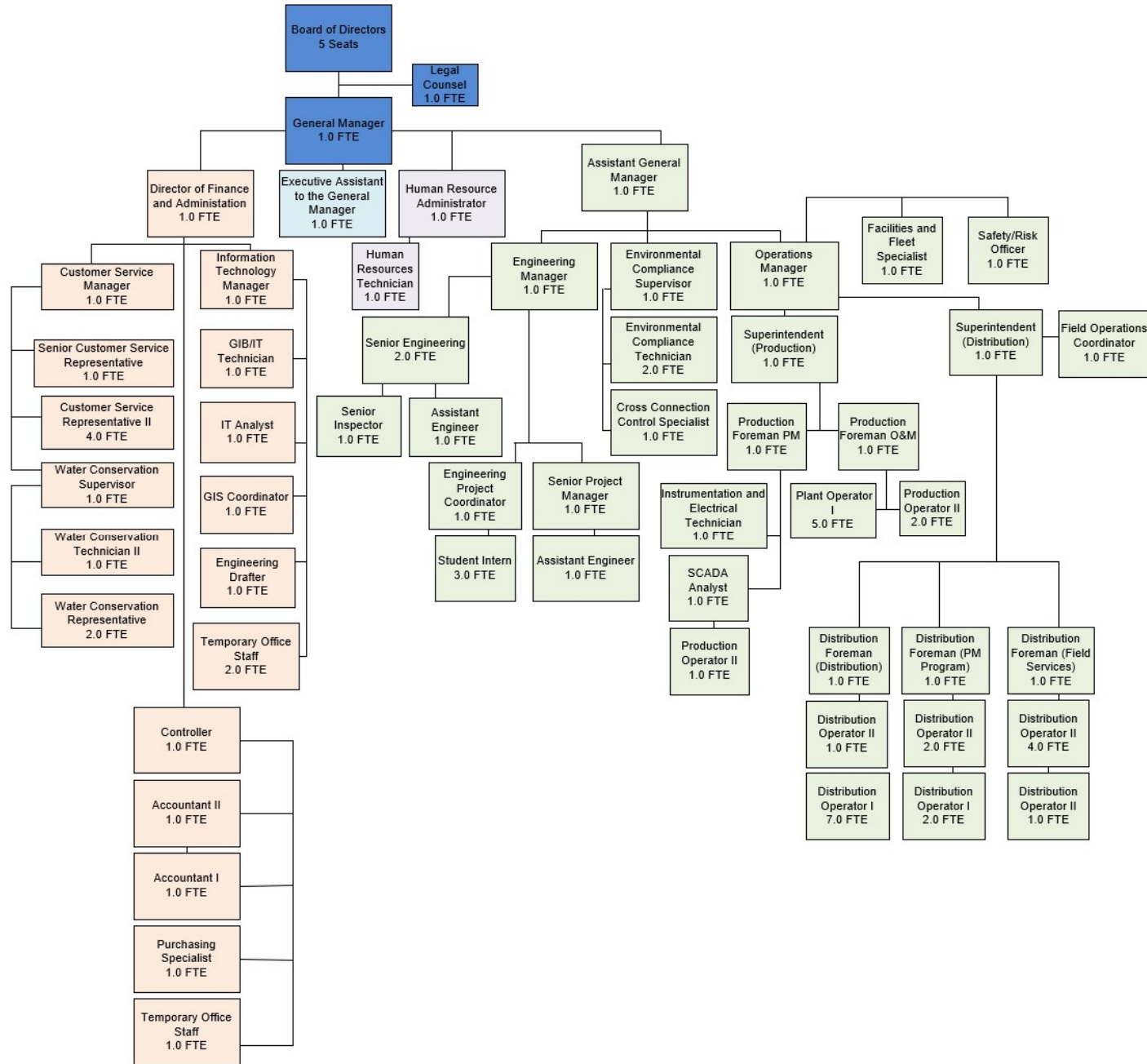

This page intentionally left blank to facilitate two-sided printing.

APPENDIX:

Appendix C: Example Interim Combined Organizational Chart



This page intentionally left blank to facilitate two-sided printing.

Example Interim Combined CWD+SSWD Organizational Chart

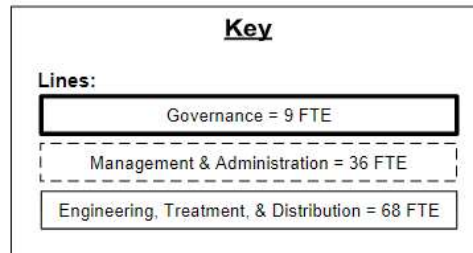
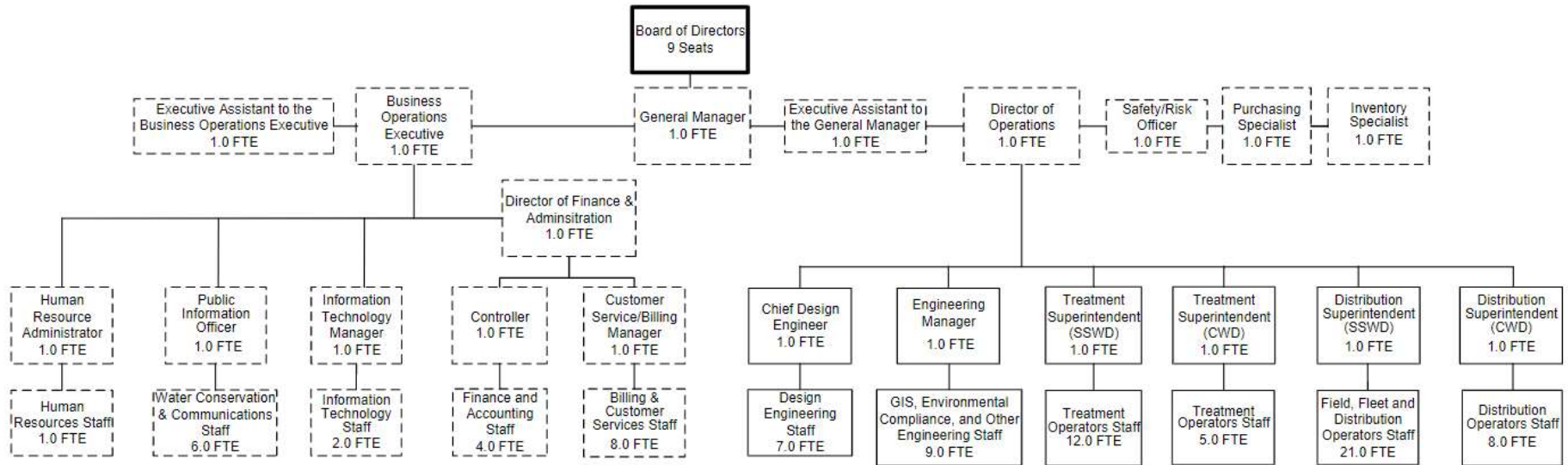

This page intentionally left blank to facilitate two-sided printing.

APPENDIX:

Appendix D: Example Long-Term Combined Organizational Chart



This page intentionally left blank to facilitate two-sided printing.

Example Long-Term Combined CWD+SSWD Organizational Chart

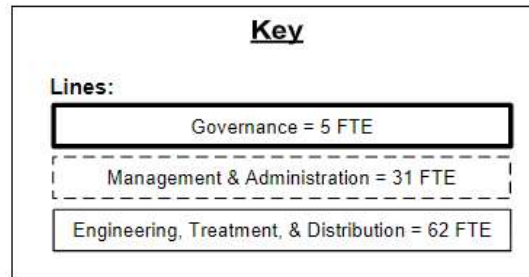
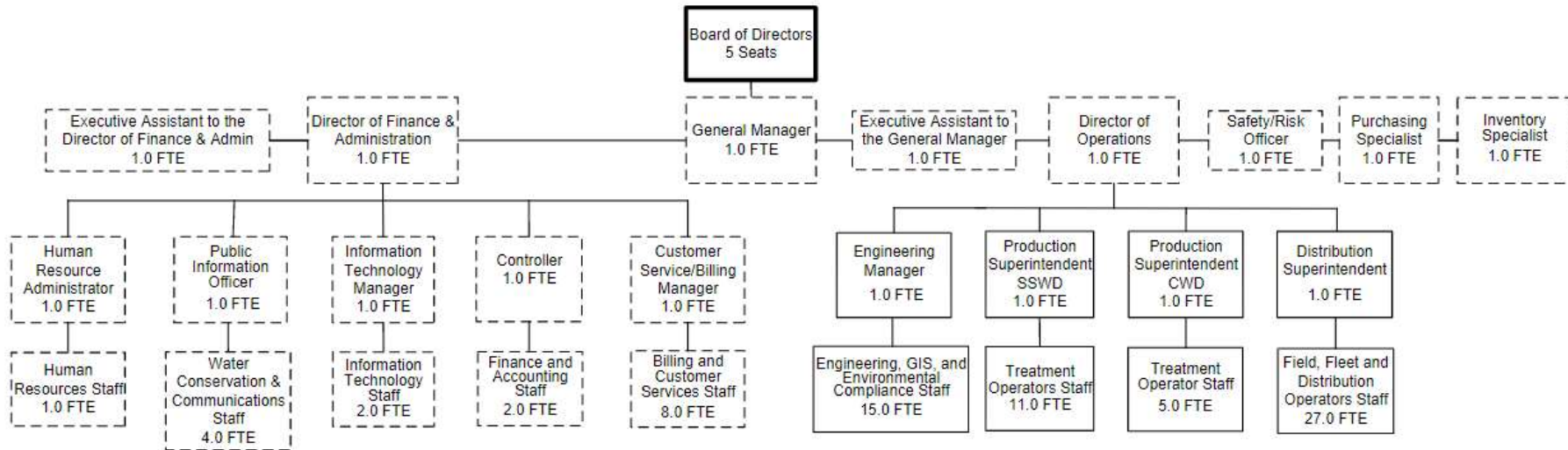

This page intentionally left blank to facilitate two-sided printing.

APPENDIX:

Appendix E: Position Compensation Comparison



This page intentionally left blank to facilitate two-sided printing.

Position & Compensation Comparison

Position Title	Agency	Starting Salary Range	Midpoint Salary Range	High Salary Range
General Office Clerk	CWD	Min. Wage	N/A	N/A
Billing Support Trainee	CWD	Min. Wage	N/A	N/A
Billing Support 1	CWD	\$29,823	\$33,037	\$36,250
Billing Support 2	CWD	\$34,607	\$38,336	\$42,065
Public Information Assistant 1	CWD	\$34,818	\$38,570	\$42,322
Water Efficiency Specialist 1	CWD	\$36,829	\$40,797	\$44,766
Billing Specialist 1	CWD	\$40,940	\$45,351	\$49,763
Distribution Operator 1*	CWD	\$43,179	\$45,875	\$48,570
Treatment Operator 1*	CWD	\$43,179	\$45,875	\$48,570
Inventory Specialist 1	CWD	\$44,322	\$49,097	\$53,873
Public Information Assistant 2	CWD	\$44,618	\$49,426	\$54,234
Water Efficiency Specialist 2	CWD	\$47,010	\$52,075	\$57,141
Customer Service Representative I	SSWD	\$47,802	\$53,778	\$59,753
Billing Specialist 2	CWD	\$48,957	\$54,233	\$59,508
Treatment Operator 2*	CWD	\$52,534	\$55,814	\$59,094
Customer Service Representative II	SSWD	\$52,584	\$59,157	\$65,730
Distribution Operator 2*	CWD	\$51,603	\$59,755	\$67,906
Administrative Assistant I	SSWD	\$54,477	\$61,287	\$68,096
Water Conservation Technician I	SSWD	\$55,366	\$62,286	\$69,207
Inventory Specialist 2	CWD	\$56,576	\$62,672	\$68,769
Communications Specialist 1	CWD	\$57,064	\$63,212	\$69,361
Administrative Specialist 1**	CWD	\$57,589	\$63,795	\$70,000
GIS Specialist	CWD	\$58,334	\$64,620	\$70,905
Senior Customer Service Representative	SSWD	\$57,842	\$65,072	\$72,302
Distribution Operator I	SSWD	\$58,306	\$65,595	\$72,883
Production Operator I	SSWD	\$58,306	\$65,595	\$72,883
Administrative Assistant II	SSWD	\$59,925	\$67,415	\$74,906
Engineering Drafter	SSWD	\$60,221	\$67,749	\$75,276
Distribution Operator 3*	CWD	\$58,672	\$67,941	\$77,209
Water Conservation Technician II	SSWD	\$60,898	\$68,510	\$76,123
Treatment Operator 3*	CWD	\$59,695	\$69,125	\$78,555
Engineer in Training	CWD	\$65,297	\$70,444	\$75,590
Environmental Compliance Technician	SSWD	\$63,606	\$71,557	\$79,507
Distribution Operator II	SSWD	\$64,135	\$72,152	\$80,169
Facilities & Fleet Specialist	SSWD	\$64,135	\$72,152	\$80,169
Production Operator II	SSWD	\$64,135	\$72,152	\$80,169
Purchasing Specialist	SSWD	\$64,135	\$72,152	\$80,169
Information Technology Technician I	SSWD	\$64,238	\$72,268	\$80,297
Human Resources Technician	SSWD	\$65,258	\$73,415	\$81,573
Executive Assistant to the General Manager**	SSWD	\$60,616	\$73,606	\$86,595

Position Title	Agency	Starting Salary Range	Midpoint Salary Range	High Salary Range
Accountant	CWD	\$67,131	\$74,364	\$81,598
Billing Supervisor	CWD	\$62,508	\$75,232	\$87,955
Administrative Specialist 2**	CWD	\$68,284	\$75,642	\$83,000
Cross Connection Control Specialist	SSWD	\$67,340	\$75,758	\$84,175
Field Operations Coordinator	SSWD	\$67,340	\$75,758	\$84,175
Accountant I	SSWD	\$68,297	\$76,834	\$85,371
Communications Specialist 2	CWD	\$69,382	\$76,858	\$84,334
Engineering Project Coordinator	SSWD	\$70,662	\$79,494	\$88,327
Information Technology Technician II	SSWD	\$70,662	\$79,494	\$88,327
Accountant II**	SSWD	\$65,744	\$79,832	\$93,920
Treatment Operator 4*	CWD	\$69,518	\$80,500	\$91,481
Senior Inspector	SSWD	\$73,306	\$82,469	\$91,633
Senior Accountant	CWD	\$74,866	\$82,933	\$91,000
Information Technology Analyst**	SSWD	\$71,825	\$87,216	\$102,607
Instrumentation Technician	SSWD	\$77,992	\$87,741	\$97,490
Engineer, Associate	CWD	\$79,383	\$87,937	\$96,490
Foreman (Production, Distribution)	SSWD	\$82,446	\$92,751	\$103,057
Scada Analyst	SSWD	\$82,446	\$92,751	\$103,057
GIS Coordinator	SSWD	\$83,186	\$93,584	\$103,983
Water Conservation Supervisor**	SSWD	\$77,212	\$93,757	\$110,303
Information Technology Coordinator**	CWD	\$85,587	\$94,809	\$104,031
Human Resources Administrator**	SSWD	\$78,302	\$95,081	\$111,860
Assistant Engineer	SSWD	\$86,211	\$96,988	\$107,764
Public Information Officer**	CWD	\$88,059	\$97,548	\$107,037
Project Manager**	SSWD	\$82,617	\$100,321	\$118,025
Safety/Risk Officer**	SSWD	\$85,653	\$104,008	\$122,362
Distribution Superintendent**	CWD	\$94,886	\$105,110	\$115,334
Superintendent (Production, Distribution)**	SSWD	\$86,570	\$105,120	\$123,671
Associate Engineer**	SSWD	\$86,746	\$105,334	\$123,922
Environmental Compliance Supervisor**	SSWD	\$88,273	\$107,188	\$126,104
Production Superintendent**	CWD	\$97,480	\$107,984	\$118,488
Customer Services Manager**	SSWD	\$89,976	\$109,256	\$128,537
Information Technology Manager**	SSWD	\$90,707	\$110,144	\$129,581
Senior Project Manager**	SSWD	\$95,011	\$115,370	\$135,730
Controller**	SSWD	\$97,254	\$118,094	\$138,934
Engineer, Senior**	CWD	\$107,088	\$118,627	\$130,166
Senior Engineer**	SSWD	\$99,759	\$121,136	\$142,513
Operations Manager**	SSWD	\$111,135	\$134,949	\$158,764
Finance Manager**	CWD	\$122,504	\$135,704	\$148,905
Engineering Manager**	SSWD	\$113,069	\$137,298	\$161,527
Director of Finance and Administration**	SSWD	\$119,058	\$144,570	\$170,082
Engineer, Manager**	CWD	\$137,984	\$152,852	\$167,720

Position Title	Agency	Starting Salary Range	Midpoint Salary Range	High Salary Range
Assistant General Manager**	SSWD	\$133,848	\$162,530	\$191,212
General Manager**	CWD	Contract	\$187,000	Contract
General Manager**	SSWD	Contract	\$191,717	Contract

*Union employee

**Overtime exempt employee

This page intentionally left blank to facilitate two-sided printing.

APPENDIX:

Appendix F: Communications Plan

This page intentionally left blank to facilitate two-sided printing.

Carmichael Water District and Sacramento Suburban Water District

Combination Study Communications Plan



Table of Contents

Background	3
Planning	4
Overarching Plan Goals and Success Measures	4
Stakeholder Identification	4
Communications Channels	6
Key Message Platform	8
Implementation Plan	11
Communication Materials	13
Tactics and Timeline	15
Evaluation	16

Background

Sacramento Suburban Water District and Carmichael Water District Strategic Business Case Analysis for a Potential Combination

In early 2020, Sacramento Suburban Water District (SSWD) and Carmichael Water District (CWD), along with five other regional water agencies, participated in the Sacramento Regional Water Utility Collaboration Study to identify opportunities for increased collaboration. The goal of the Study was to identify opportunities for additional operational and financial efficiency, and to improve service provision to customers.

On June 21, 2021, the SSWD Board of Directors accepted the Regional Study and directed its General Manager to continue identifying collaboration opportunities with the Carmichael Water District. Both Districts desire to become more efficient in working together to minimize costs to their customers and optimize the use of their water supplies, personnel, equipment, infrastructure and other resources, and enhance their impact on state and federal policies.

A study of how the two agencies could combine began in April 2022. A comprehensive report is expected by fall 2022, which will include recommendations of how consolidation or shared services for the Districts might proceed and presents a business case analysis for combining services. If conditions appear favorable, a timeline for combination will be proposed.

This analysis of the Districts provides an opportunity to reinforce customer service and benefits, as well as mission, vision, and values of the organizations to key stakeholders—both internal and external. Getting buy-in from stakeholders will be a critical success factor during and beyond this Study if consolidation is pursued. This strategic communications strategy is intended to ensure that the right messages about the Combination Study are communicated to keep every stakeholder informed and reduce employee anxiety.

Currently, internal stakeholders have been informed along the way since 2020 with opportunities for employees to ask questions. The most frequently asked question is about impacts on the workforce. Community-wide communication about the Combination Study to external stakeholders has primarily only been through each Districts' Board meetings and the public 2x2 Ad Hoc Committee. Members of the public who tend to be more engaged and follow board agendas and meetings will have a higher awareness, but they represent a small percentage of customers and the public. The SSWD website includes an overview of the two studies, but it does not appear on the CWD website.

The release of the Combination Study Report will ignite interest in the potential merger, job security topics, workforce issues, and benefits to customers. The goal is to inform constituencies about the feasibility study process and set expectations of next steps. With state water and environment regulators and policy makers based in Sacramento, placing a story in area news outlets can reach key local, regional, and state stakeholders. Proactively informing stakeholders will help ensure that the right messages are communicated. Internally, keeping employees “in the know” and reducing employee anxiety may boost morale and help retain talent. These efforts can also help mitigate potential issues with labor. Externally, this is an opportunity to reinforce customer messaging about services and benefits, as well as restate the mission, vision, and values of both organizations to key stakeholders—both internal and external.

Planning

The enclosed strategic communications plan and messaging framework places a high priority on communicating internally and outlines a path to communicating with external audiences. Representatives at each agency are a great asset and serve as front line ambassadors—their interactions with customers build trust in their water provider every day. Engaged and informed employees perform better, experience less burnout, and stay in organizations longer.

Overarching Plan Goals

- Raise awareness and manage expectations that a feasibility study is being conducted to examine shared resources and efficiencies.
- Clearly communicate to stakeholders how and what frequency they will be kept informed about the study.
- Strengthen and formalize internal and external communications to build and improve relationships with stakeholders.
- Expand and diversify communication delivery and provide a framework for communications and outreach that enables staff from both Districts to communicate and engage effectively and efficiently.
- Position both water districts as responsible and reliable clean water service providers and caring community partners.

Success Measures

- The Districts are not receiving many inquiries now, but the true test is when the Study Report is published and released through the Boards and 2x2 Committee and added to the websites. More inquiries to customer service could be an indication of more awareness.
- Seen as a positive that an increased number of inquiries from the media is an opportunity to tell the right story and position the Districts as thought leaders in the region.
- Local community recognition and support for the value of service provided by the Districts.
- Signs of trust -- internally and externally.

Stakeholder Identification

Both water districts identified stakeholders for the purposes of this Plan as individuals, groups, organizations or political entities that have an interest in the Study and are assumed to be directly or indirectly affected by the outcome of decisions related to the Study.

- Employees of each District
- Parks Departments are a shared and interested stakeholder
- Governing bodies for each District
- Customers of each District
- Water Forum Environmental Caucus
- Regional Water Authority
- Other water and environmental advocacy organizations
- City of Sacramento
- City of Carmichael
- County Board of Supervisors
- Other local elected officials
- Regulators
- Vendors
- News Media
- LAFCO
- Business community, incl. Chamber of Commerce and Taxpayer Advocacy Groups
- HOAs
- Civic organizations

Stakeholder Mapping

On one end of the spectrum are those who are most interested and who wield the most influence over your success. At the other end are those who are not heavily engaged and have the least influence.



Communication Channels

Each District has its own outreach and communications program, generally relying on some combination of websites, bill inserts, bill messaging, conservation education, and outreach events to reach customers. The key is to communicate early and often. Each District also has internal communication channels to reach employees, governing boards and policymakers.

For this Plan, the focus is on using existing channels while supplementing with active outreach to key stakeholder audiences to inform stakeholders and engage them in attaining the goals of the Study. What follows is an inventory of available communication channels and resources for each of the participating agencies.

Carmichael Water District	Channel	Frequency/Notes
Internal	Staff, tailgate, road show meetings	Reach field and administrative staff
	Employee email & newsletters	Reach administrative staff
	Employee Bulletin Boards and Gathering Areas (break/lunch rooms)	Posters, fliers
	Employee Intranet	Official location of employee news
	New employee orientations	Transparency with staff just joining the organization
	Board & Committee meetings	Monthly
External	Active in community organizations and signature events	Neighborhood associations, civic associations, Speaker's Bureau, community events
	Newsletter	Establish a regular cadence
	Bill inserts	Monthly, limited character space, could be missed or overlooked
	Customer service counter and kiosks	Location to place fact sheets, newsletters, brochures, current events
	Direct mail	If the Study proceeds
	Social media	Nextdoor
	Website	Mirror landing page for the Study as on SSWD website;
	Business & civic groups (Carmichael Chamber, Kiwanis, etc.)	Information distribution to members and speaking engagements
	Establish e-news proactive distribution	As needed to release news and notifications
	Facility tours	Opportunity to share news of the District

Sacramento Suburban Water District	Channel	Frequency/Notes
Internal	Staff, tailgate, road show meetings	Reach field and administrative staff
	Board and Committee meetings	Monthly
	Employee bulletin boards and gathering areas (break/lunch rooms)	Posters, fliers
	Employee email	Reach administrative staff
	Employee intranet	Official location of employee news
External	New employee orientation	Transparency with staff just joining the organization
	Customer service counters, kiosks	Location to place fact sheets, newsletters, brochures, current events
	Community and industry events and forums	Tabling/exhibiting opportunity to distribute information; prep staff to answer basic questions
	Speaker's Bureau	Expand to offer presentations to civic, nonprofits, and faith based
	Newsletter	Establish a regular cadence
	Bill inserts	Monthly, limited character space and often not read or overlooked
	Direct mail	As needed, not as likely to be overlooked
	Social media	Establish 1-2 leading platforms followed by key stakeholders
	Website	Update name of the Study on "About" menu
	Business & civic groups (Carmichael Chamber, Kiwanis, etc.)	Information distribution to members and speaking engagements
E-news	As needed to release news and notifications	
Facility tours	Opportunity to share news of the District	

Key Message Platform

A message platform provides consistency to Study communications. Simple, informative and clear messages have been developed and tailored to internal and external stakeholder audiences based on relevancy.

Spokespersons

The 2x2 Ad Hoc Committee is meeting regularly to evaluate collaboration opportunities, up to and including a potential combination of the two districts. Each District General Manager will serve as the lead spokesperson for their agency and/or an informed Board will speak as body and not individually.

Each agency understands the importance of not speaking for the other. For inquiries or speaking opportunities where one spokesperson should represent the Study there is consensus that Dan York, General Manager of Sacramento Suburban, should be the spokesperson because he is the contract administrator for the Study.

Guidelines for message development

Each agency representative will determine the most effective communication method(s) to reach specific audiences based on their respective needs and feedback provided, and tailor communication delivery appropriately.

Messages should be consistent across every communication channel (website, newsletters, presentations, meetings, etc.) When communicating changes or decisions, clearly explain the “why.”

The Study goals should be the leading focus for each District and the 2x2 Ad Hoc Committee members when communicating about the Study. Customers are a top priority and central to the strategic direction of the Study. The connection to customer service is top of mind in message development.

Message themes

The following themes help guide message development and maintain consistency as the Study moves through various phases:

1. We are experts and provide a valued service.

- A. Employees from each District work hard every day to deliver high quality, reliable water service to about 240,000 people in north Sacramento County.
- B. As water providers we work 24/7/365 to run complex water systems. With significant infrastructure improvement plans, we’re staying on top of maintenance, upgrades, and new projects needed to keep these systems running effectively and efficiently.
- C. The foresight and legacy of those who created and lead our agencies allows us to provide high quality, reliable drinking water for our customers today.

2. The CWD/SSWD Combination Study will examine the feasibility, benefits and risks of a shared path to a secure water future.

- A. The Study builds on our history and each water provider's core responsibility and mission of providing and delivering a high-quality, reliable supply of drinking water—we'll continue to focus on the importance of providing excellent water quality and maintaining our infrastructure.
- B. Our utility environment is changing, so we must find new ways to serve our region efficiently by expanding partnerships and embracing technology to improve our customers' experience.
- C. The Study considers trends in our industry and communities that affect each of our water agencies and guides us to address opportunities and challenges; like water supplies and demand, drought, pressure to keep rates affordable, and regulatory changes.

3. The CWD/SSWD Combination Study is being developed with input from employees and governing boards.

- A. The Study's 2x2 Ad Hoc Committee includes leadership and management from both participating water districts.
- B. Because the Study is designed to serve our customers, employees, and stakeholders, we intend to include their perspectives where possible through surveys, focus groups, tours, community meetings, and/or open houses.
- C. The governing boards of each water district has reviewed and formally approved our efforts to develop the Study.

4. This Study is focused on providing a sustainable approach to a secure water future for our customers.

- A. We all have something at stake when it comes to water, so we are continuing to build partnerships to ensure we have safe and reliable water to support residents, businesses, and other public agencies, such as schools and parks, in our communities.
- B. The Study partners will collaborate to find solutions for modernizing our water systems and the policies and processes that help reduce costs and encourage efficiency.
- C. Together, we have a valuable contribution to make. We know you care about your water, so we'll help you learn more about the essential service we provide.

5. Every employee plays a role in achieving our vision.

- A. Employees are our most important asset.
- B. The Study is tied directly to the success of our region and relies heavily on our employees.
- C. Every role, from field crews, operators, and engineers to customer service representatives and accountants is connected to the Study goals of efficiency, improved services, and cost savings.

6. Employee feedback and input will continue to be important as we enter into different phases of the study.

- A. Your manager and supervisor will work with you to show how your work connects to the Study.
- B. We'll connect our employees to our successes and report on how we are doing on achieving our goals.
- C. We expect you to tell your supervisor and manager how things are going and to make suggestions for improvement.

Implementation Plan

INTERNAL

Communicating to raise awareness and understanding about the Study with employees and governing bodies.

Gaining awareness, interest, and ultimately engagement among the Districts' employees and governing bodies is critical for the Combination Study to be successful. Telling the story of why the partner agencies have initiated the Study and how employees will influence and be affected by the Study is at the heart of enhancing employee engagement. Employees who understand how their work impacts the overall success of the Study are more likely to take actions to align with the Study's goals and will help move it forward.

Core principles that connect employees to the Study:

Communicate from the top down and share progress

While most employees prefer to hear job-specific tactical information from their immediate supervisor, they expect to hear organizational strategy from leadership, and especially not from a local news story. Although employee input is used to develop the Study, the strategy behind the Study comes from the senior levels of their organizations. Leadership is responsible for communicating the priorities, listening and responding to feedback, setting the tone and energizing people behind common goals.

Recognize and celebrate employee contributions

Employees will want to be recognized for their contributions to the success of the Study. Recognition can take many forms from a simple shout-out to elaborate programs with rewards and prizes. But the most important aspect is to create opportunities to acknowledge employee contributions, and opportunities for recognition among peers and a way to share examples of success as inspiration to other employees.

Internal Communication Strategies for Employees

As the Study moves forward and identify opportunities to share services, change management will become very important. In fact, the Study could risk failure if leadership is not maintaining a cadence of information sharing that keeps employees engaged, even when they are working on their day-to-day duties.

The following strategies are meant to work together to enhance internal communication efforts that may already be in place and bolster efforts to successfully anticipate and manage change by infusing additional internal communication opportunities into future phases of the Study.

Meet employees where they are

Employees are out in the community, driving vehicles, working both in teams and independently, and being responsive to the needs of customers. That means traditional communication methods like emails and handouts can get lost while prioritizing daily work. Inboxes are often flooded with email, so newsletters can get set aside for any available "me time" that comes along, which may mean they are forgotten.

To reach employees, messages should be brought to where employees spend their time. Using visual management boards in work areas or break rooms can be better for employees who are rarely on email. These boards should be specific to the people who work in this area—they can include team updates, progress toward team goals, recognition of team members and show areas that need attention.

Know your audiences

Information clutter happens when the quantity of information being sent overwhelms the employee. This can happen when there is not a single hierarchy that determines what messages go to all employees and what information is “need to know” vs. “nice to know.” For the “need to know” groups, can the message be tailored so it feels most pertinent? For the “nice to know” groups can the message be sent in a way that doesn’t clog up communication channels and distract from more important information?

Additionally, general meetings with employees about the Study should be very short. Employees need to hear about strategy from leadership, but their managers and supervisors should connect their role to the Study as needed. Develop a way to share updates on the Study at in-person/virtual meetings that is highly pertinent.

Optimize huddles

Huddles are brief touchpoints that occur for an entire team frequently—even daily. Tailgate talks or stand-up virtual meetings are examples. They are effective because they are frequent, brief, in-person (or over the phone) and to the point. They can also be used to gain quick feedback on employee understanding.

Prepare managers as messengers

Trust is important in conveying messages. Those who work most closely with teams are naturally the most trusted sources of information. Managers are often the first line of feedback and can be highly useful for leadership to hear from. Managers should be equipped with the knowledge they need and the tools and structures to communicate effectively with their team. Preparing managers does not replace the need for employees to hear directly from leadership, but it is mutually beneficial.

Communication flow – vertically and horizontally

For the Study to be successful, employees must be engaged across organizations, disciplines and departments. Information typically flows vertically, but in practice, silos prevent information from flowing horizontally.

Think beyond the written word

Use of graphics, charts, photos and video can help draw employees’ attention and make the information easier to digest. Low-cost, simple videos can engage employees in a way that will be difficult for print materials to match, and they are perfect for time-pressed employees.

Establish consistent messaging cadence

To break through information clutter, establish a consistent way that information is presented about the Study. Setting patterns for information-sharing can help keep messages clear and direct.

Communications Materials

Communications materials provide a home for messages, both overarching themes and tailored, and are delivered via the communication channels described on page 7 in this plan. For example, a brief fact sheet for the Study with visuals and infographics could simplify the narrative, separate fact from fiction, address general audience questions, and manage expectations and hearsay. Elements from the fact sheets can be repurposed for other channels to drive people to the websites to learn more.

Similar to visuals and infographics for printed documents, short videos are eye-catching and the most viewed digital content. Creating short informative videos does not require heavy production and expensive videographers. An informative, interesting 90-second video can be created with free or inexpensive software using some images and text and posted to the website and social media and linked in e-news and shared through e-mail. Smartphone video quality continues to improve and is sufficient for quick, timely video content.

The following is an outline of communication materials that would be appropriate to support the goals of the Study:

Material	Description	Stakeholders	Channels
FAQ's	Q&A that describes what the Study is, why it was initiated, and answers questions employees may have	Employees	Meetings Employee Communication
One-Page Handout	Single page that describes what the Study is and why it was initiated	All	Websites Bulletin Boards Employee Communication Employee Orientation Customer Service Counters
Monthly Study Update	Template for a one-page highlight of recent and upcoming activity	Employees Elected Governing Boards Regulators	Websites Presentations Board Updates Employee Communication
Video	Short, 3-4-minute video to recap both studies with status update. Video is more engaging; 80-95% retention rate for video messaging vs written messages.	All Employees Elected Governing Boards Regulators	Employee Communication Websites Presentations Board Updates

Material	Description	Stakeholders	Channels
Case Studies	As the Study moves into future phases and projects are developed case studies showing successes can be shared, video would be a preferred method	All	Web Site Presentations Board Updates Employee Communication
Presentation	Short, 10-15-minute presentation showing the highlights of the Study as it evolves and pulling several case studies in	Business Community Customers Elected Speaker's Bureau Regulators Water Industry Organizations	Presentation Deck PDF on the Website Video Presentation on website, social media, e-news
Infographics	Graphic representation of the process and timeline for the Study and demonstrating case studies of successes as they become available	All	Web Site Presentations E-news Employee Communications

Tactics and Timeline

The following tactics are designed help with acceptance of the Combination Study Communications Plan to achieve the goal of engaging and informing stakeholders and employees giving them the knowledge and inspiration they need to help realize the Study’s next steps.

Tactic	When	Who	Detail
Determine messaging; ensure consistency	August '22	District Staff	Archive references to the previous regional study. Consistent use of “Combination Study.” Determine look and feel for materials (design scheme, how to use logos, etc.), ensure all materials are branded consistently.
FAQs	August '22	District Staff	FAQ to describe what the Study is, purpose, goals, and timeline. Attempts to proactively answer employee, customer, and governing body questions. Committee to brainstorm initial questions, add additional questions as they’re posed. For more interest and engagement, produce a video QA using staff and GMs from both agencies.
One-page handout	August '22	District Staff	Streamlined version of the FAQ. Highlight messaging themes described in this Plan. Include high-level messaging about the Study. Use infographics, images, and color to add interest and readability.
Presentation	August '22	District Staff	Use FAQs and messaging themes to develop an introductory presentation that can be tailored/tweaked for specific audiences. Presentation should be accessible and editable by spokesperson – can be tailored to address any audience.
Presentation Schedule	Ongoing	District Staff	Use stakeholder list to start prioritizing and scheduling presentations to stakeholder groups. Prioritize elected officials, water organizations, business/civic leaders.
Regular communications check-in via 2x2 Committee and Study update template	Every Committee meeting	2x2 Committee	<p>During 2x2 Ad Hoc Committee meetings develop an agenda item that focuses on what messages should be communicated to which audiences and check-in on how communication is progressing.</p> <p>Develop a document template that can be used to share information coming from the Committee on a regular basis for key stakeholders like governing boards and employees.</p>
Employee Road Show	Sept. '22	Both Districts	<p>Tweak standard presentation to include message themes related to employees. Present same presentation at all staff meetings within each agency – if there isn’t a staff meeting for a particular group, set up a specific time to present to them.</p> <p>Include information on current/future communication channels where they can find info and ask questions.</p>
Employee Information Hub	August '22	Both Districts	Put the information somewhere where all employees can access it – preferably an intranet site but if that isn’t available – in a shared file somewhere. Establish a communication channel for employees to ask questions.

Evaluation

Success for this plan will be measured in two ways, outputs and outcomes.

Measurable Output Targets

- ✓ 2x2 Committee to read, reviewed, discuss and approve the Study communication plan.
- ✓ The strategies, tactics, and messages have been shared with all internal staff who may have responsibility to execute or use them.
- ✓ All messages and materials, including the websites and printed materials have been reviewed and updated to ensure they are applying the messages in this plan consistently.

Measurable Outcome Targets

Measuring outcome, or changed behaviors, attitudes, and level of awareness of stakeholders requires having baseline understanding of these items. While a stakeholder survey conducted before the Combination Study could have provided insights and baseline data, it's never too late to gather information and feedback. Once the Study is completed and next steps are known, a stakeholder survey is a valid tool to gain feedback and insights for communications planning moving forward. Other ways to measure change is through focus groups or informal panels, or simple but more frequent polling on social media on specific topics. In absence of a social media presence, electronic news and newsletters can be used.

Google Alerts

In addition to the customer survey, the Districts can track customer knowledge and awareness by monitoring their named and certain key words in social and traditional media. This means listening to what's being said and any other topic that's important.

Website

For website outcomes, each District can set up analytics and look for increases in the monthly web page visits and visits from key sources.